

Dynamics and Geometry of Moduli Spaces

**Lecture 3 (slow down).
Ramified covers. Cyclic covers.
Holonomy. Monodromy.
Intersection number.**

Anton Zorich
University Paris Cité

March 12, 2024

Ramified covers

- Ramification point
- Conical singularity
- Holomorphic 1-form in a neighborhood of a zero
- Riemann–Hurwitz formula

Hyperelliptic surfaces

Quadratic differentials and holomorphic 1-forms

Cyclic covers

Relative homology.
Poincaré duality.
Intersection number

Ramified covers

Ramification point

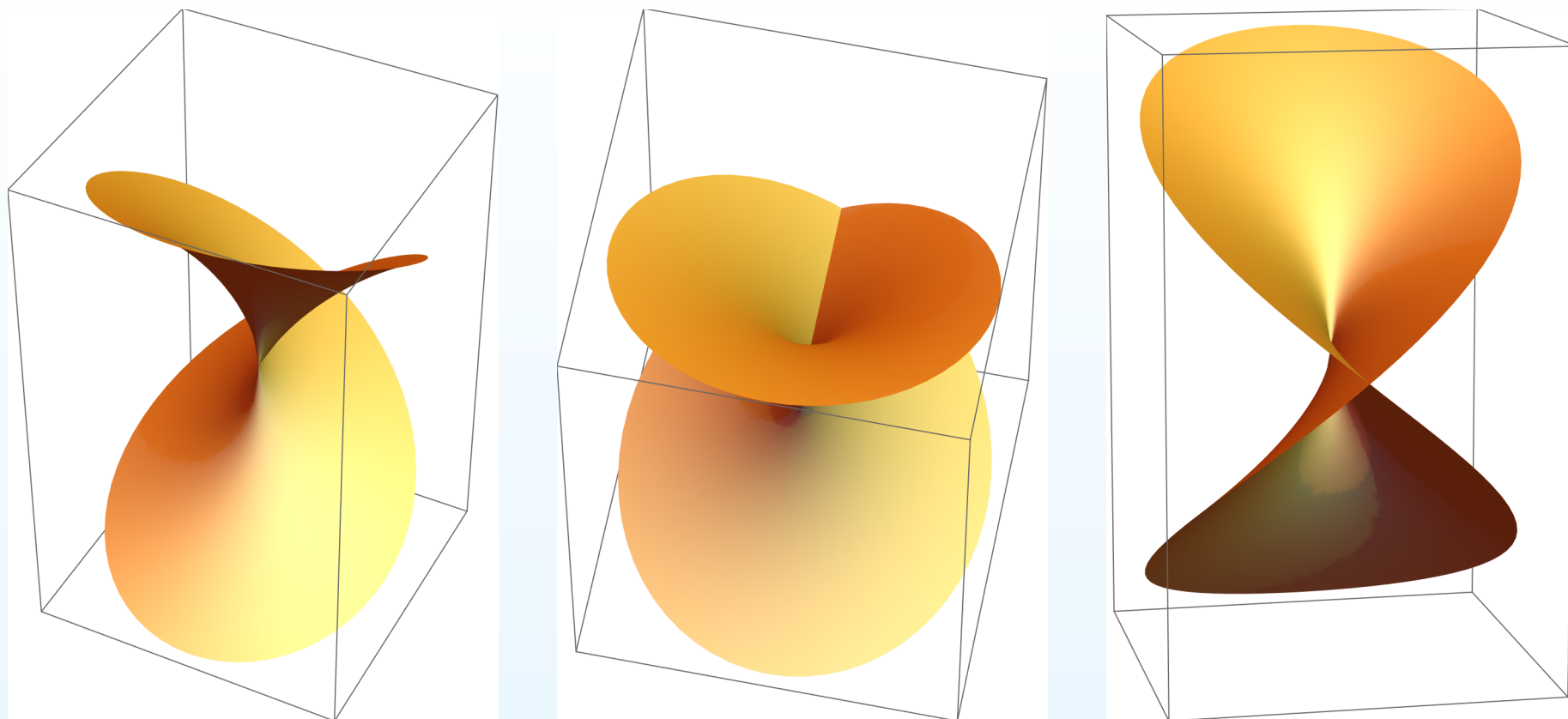

An attempt of a graphical representation of a neighborhood U of the point $O = (0, 0)$ of the Riemann surface C given by equation $z = w^2$, where U is “seen from different angles”. Here the bottom plane symbolizes the complex plane \mathbb{C} endowed with a coordinate z . Note that the point $O = (0, 0)$ is nonsingular: we just cannot use z as a local coordinate in U , as we cannot use y as a local coordinate in a neighborhood of $(0, 0)$ on a real parabola $y = x^2$.

General ramification point

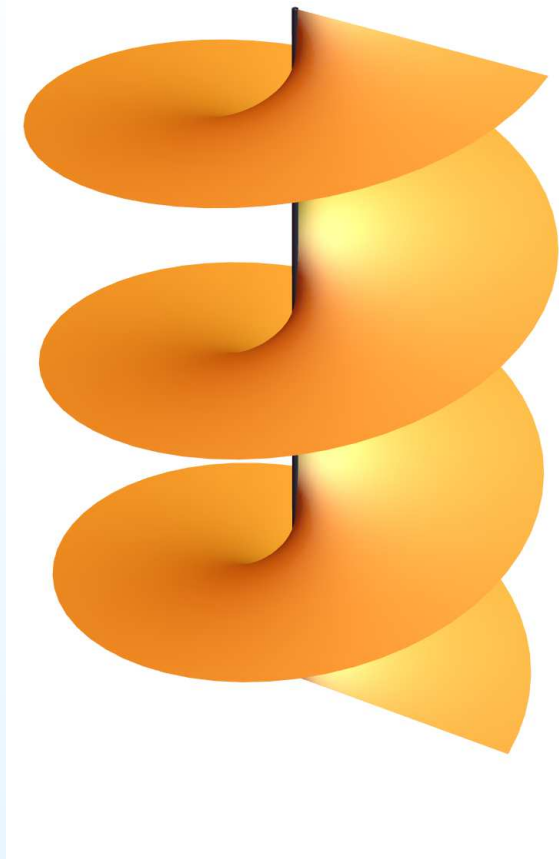

An schematic representation of a neighborhood of a ramification point of degree n on a Riemann surface C given in local coordinates by equation $z = w^n$.

Traditionally by a *ramification point* \hat{P} we call a point on a branched cover \hat{C} , and by a *branch point* $P = p(\hat{P})$ we call its image under the cover $p : \hat{C} \rightarrow C$.

Example: conical singularity with cone angle 6π

Locally a neighborhood of a conical point looks like a “*monkey saddle*”.

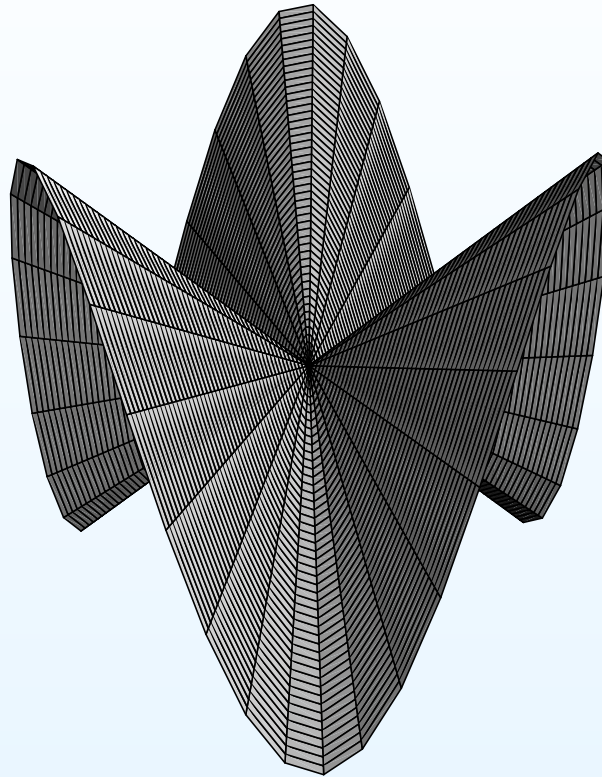

A neighborhood of this conical point with a cone angle 6π can be glued from six metric half discs. If we consider a ramified triple cover over a regular flat domain, then this would be a shape of the induced flat metric on the cover in a neighborhood of a ramification point. The conical point is a *singularity of the metric*; it is *non-singular* as a point of a smooth surface (complex curve)

Holomorphic 1-form in a neighborhood of a zero

We say that a holomorphic 1-form ω on a Riemann surface X has a *zero of degree k* at a point P of X , if one can choose a coordinate w in a neighborhood $\mathcal{W}_{(w)}$ of P in which ω has the form $\omega = w^k dw$.

Example. Consider a ramified cover $p : \mathbb{C}_{(u)} \rightarrow \mathbb{C}_{(z)}$ of degree $k + 1$ defined by equation $z = u^{k+1}$. Consider a holomorphic form $\omega = dz$ defined in a neighborhood of 0 in the image of p . The induced 1-form in the preimage has the form $p^*\omega = d(z(u)) = d(u^{k+1}) = (k + 1)u^k du$. Changing the coordinate u to a coordinate $w = (\sqrt[k]{k + 1})u$ we see that $\omega = w^k dw$ has a zero of degree k at the preimage of the cover.

This explains why a zero of degree k of a holomorphic 1-form corresponds to a conical singularity of a flat metric with cone angle $2\pi(k + 1)$, which, in turn, corresponds to a ramified cover of degree $k + 1$ over a regular point of a flat metric.

Riemann–Hurwitz formula

Consider a ramified cover $p : \hat{S} \rightarrow S$ of degree N with ramification points $\hat{P}_1, \dots, \hat{P}_k$. Let d_1, \dots, d_k be the corresponding ramification indices. Then

$$\chi(\hat{S}) = N \cdot \chi(S) - \sum_{j=1}^k (d_j - 1).$$

Proof. Consider a triangulation of S having vertices at all branch points (and possibly at other points). Consider induced triangulation of \hat{S} . Using the resulting triangulations we compute Euler characteristic of \hat{S} in terms of Euler characteristic of S taking into consideration a defect coming from ramification points.

Excercise. Using Riemann–Hurwitz formula prove that a hyperelliptic surface given by equation

$$w^2 = (z - z_1)(z - z_2) \dots (z - z_{2g+2}),$$

has genus g .

Ramified covers

Hyperelliptic surfaces

- Hyperelliptic surfaces
- Elliptic curve
- Basis of cycles on a hyperelliptic surface

Quadratic differentials and holomorphic 1-forms

Cyclic covers

Relative homology.
Poincaré duality.
Intersection number

Hyperelliptic surfaces

Hyperelliptic surfaces

A Riemann surface C given by equation $w^2 = (z - z_1)(z - z_2) \dots (z - z_n)$, where $z_i \neq z_j$ are distinct complex numbers when $i \neq j$ is called *hyperelliptic*. Compactifying the complex plane $\mathbb{C}_{(z)}$ at infinity and compactifying C we get a natural double cover $P : \overline{C} \rightarrow \mathbb{CP}^1$ having double ramifications over the points z_1, \dots, z_n of $\mathbb{CP}^1 = \overline{\mathbb{C}}$.

Excercise. Verify that the cover p has double ramification at $z = \infty \in \mathbb{CP}^1$ if n is odd, otherwise it is unramified at $z = \infty \in \mathbb{CP}^1$.

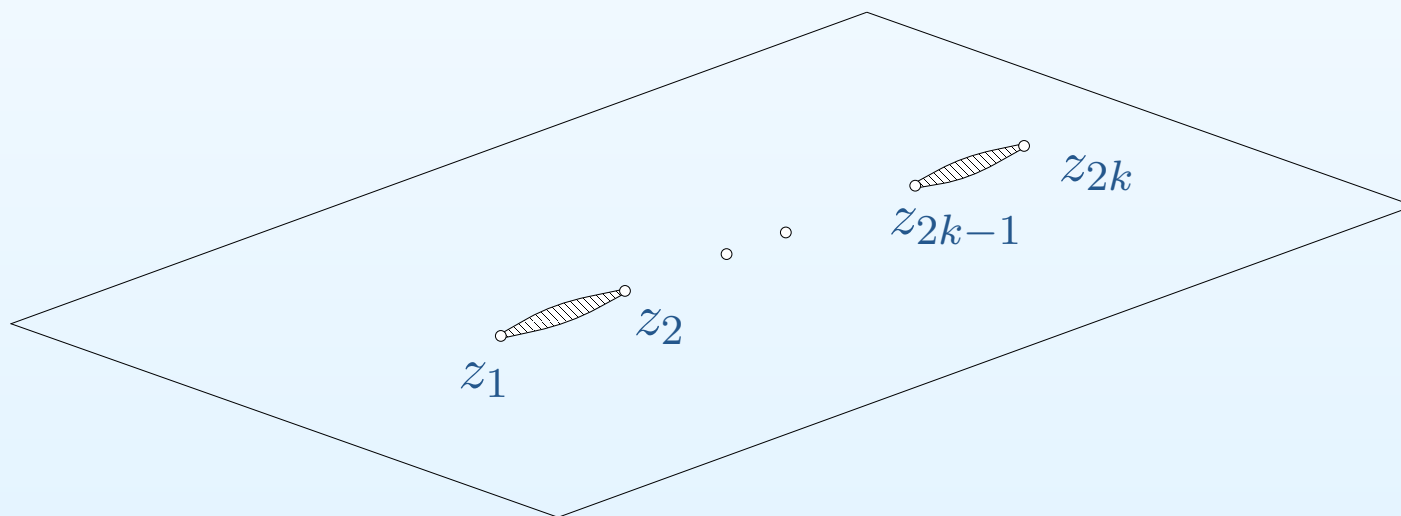

Suppose that n is even: $n = 2k$. Removing segments $[z_1, z_2], \dots, [z_{2k-1}, z_{2n}]$ from \mathbb{C} and their preimages, we get already a regular (unramified) double cover.

Elliptic curve

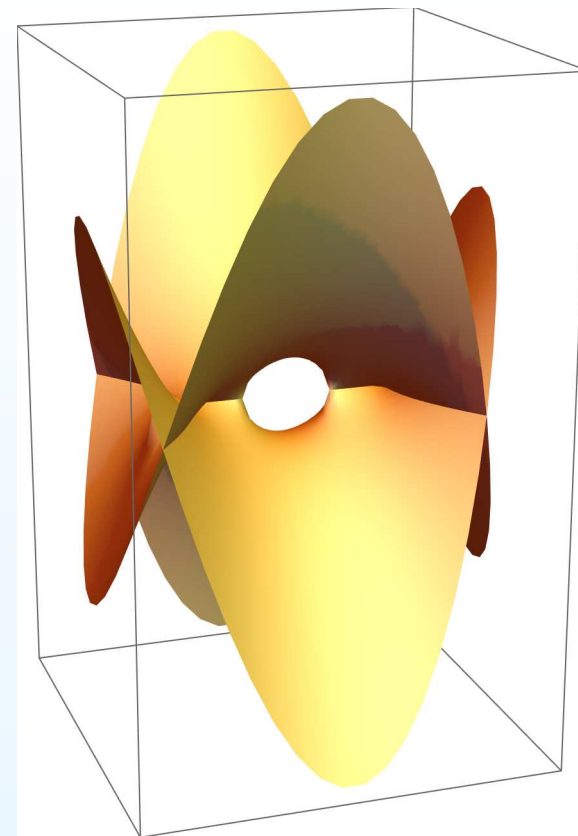
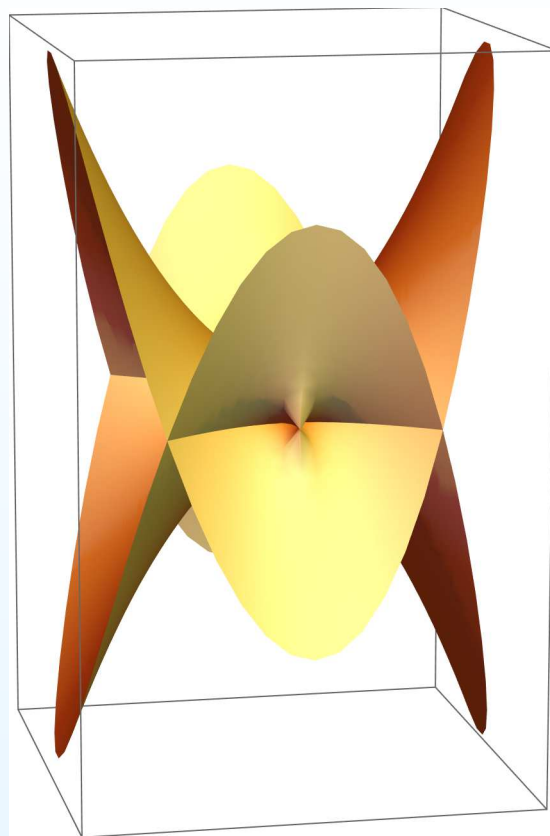
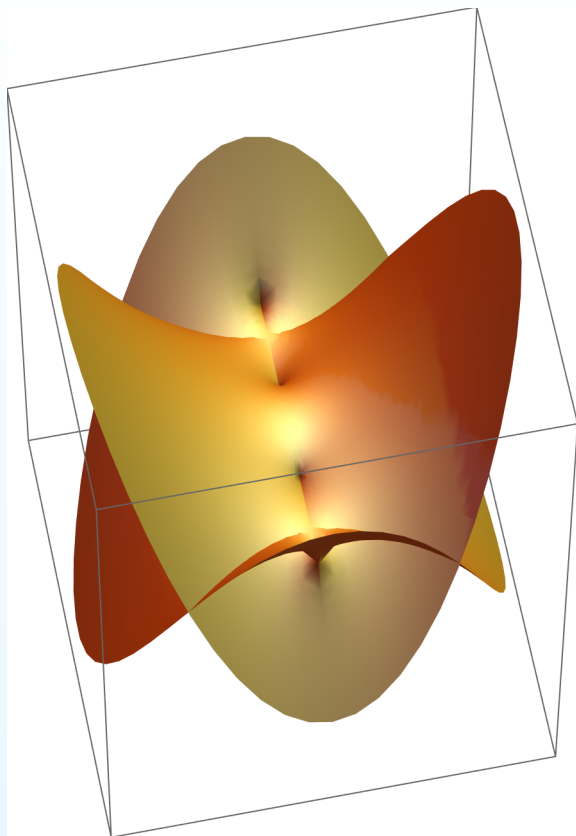

A schematic graphical representation of a (complex) elliptic curve

$$w^2 = (z - z_1)(z - z_2)(z - z_3)(z - z_4),$$

with real z_i . Pictures represent the same surface seen from different angles.

Basis of cycles on a hyperelliptic surface

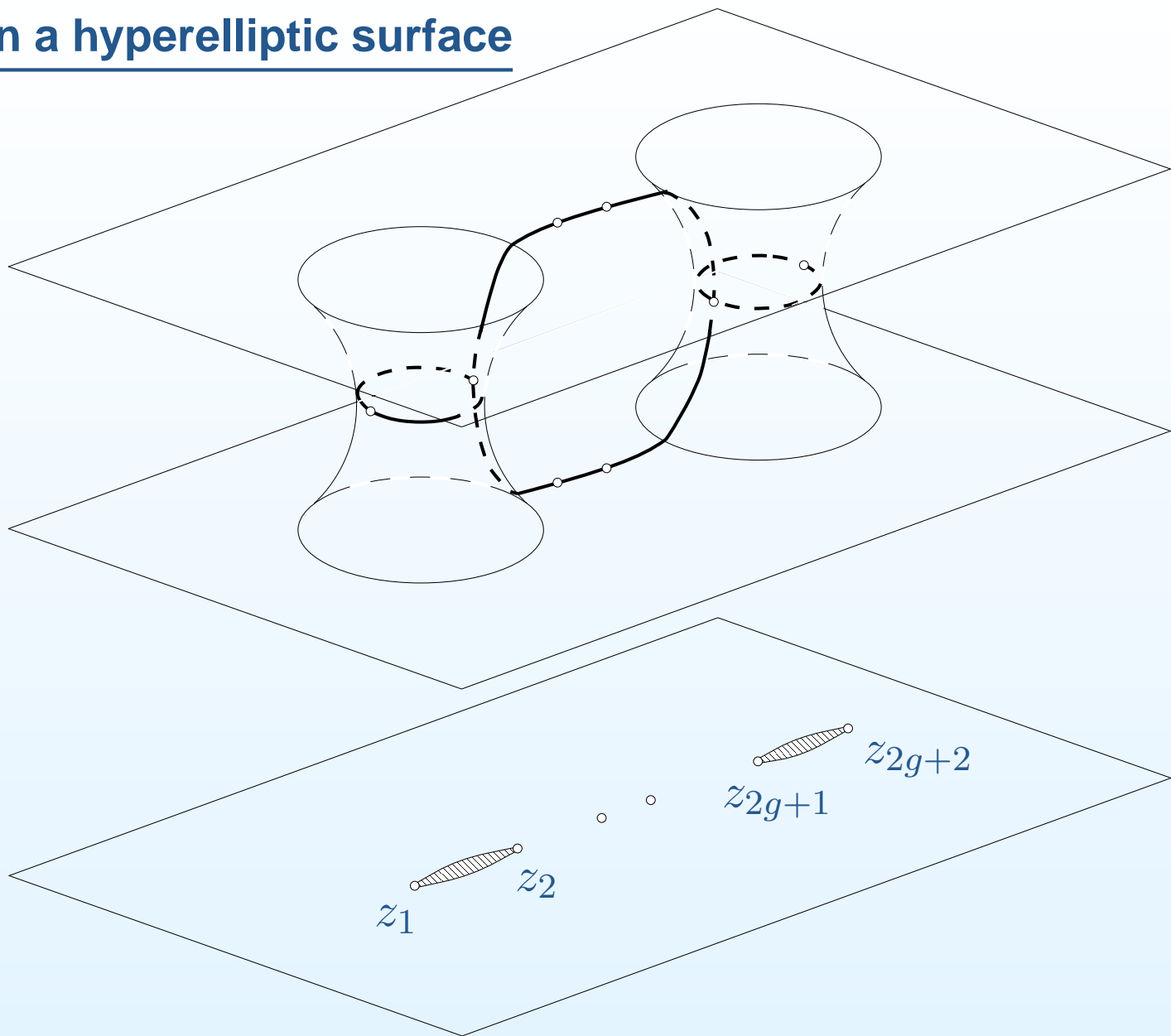

Verify that preimages of closed curves encircling segments $[z_1, z_2], [z_2, z_3], \dots, [z_{2g}, z_{2g+1}]$ are closed curves which form a basis of cycles on \hat{C} .

Ramified covers

Hyperelliptic surfaces

**Quadratic differentials
and holomorphic
1-forms**

- Flat metric associated to meromorphic quadratic differential
- Canonical double cover
- Torus as a ramified double cover
- Elliptic surface
- Families of hyperbolic surfaces

Cyclic covers

Relative homology.

Poincaré duality.

Intersection number

Quadratic differentials and holomorphic 1-forms

Flat metric associated to meromorphic quadratic differential

Definition 1. In a simply-connected coordinate chart \mathcal{U} , in which a meromorphic quadratic differential $q(w) = \phi(w) \cdot (dw)^2$ does not have zeroes and poles, it can be represented as a square of a holomorphic 1-form $q(w) = (\pm\omega(w))^2 = (\pm\sqrt{\phi(w)}dw)^2$. The form ω is defined up to a sign. It induces a flat metric, which does not depend on the choice of the sign. It also determines vertical and horizontal foliations orthogonal in our flat metric.

Definition 2. Let $w = u + iv$. Define a volume element in local coordinates as

$$-\frac{1}{2i}|\phi(w)|dw \wedge d\bar{w} = |\phi(w)|dx \wedge dy$$

and a length element as $\sqrt{|\phi(w)|}|dw| = \sqrt{|\phi(w)|}\sqrt{du^2 + dv^2}$.

Exercise. Prove that the definition does not depend on coordinates: defining the length and volume element in different coordinates we get the same geometric objects. (See, sections 7.2 and 8.1.3 of notes of B. Petri for details.)

Exercise. Prove equivalence of the two definitions.

Canonical double cover

Any nonorientable surface admits a canonical double cover which is already orientable. Namely, we take an atlas of simply-connected charts and take two copies of every chart. If transporting a tangent frame along a closed path we get the initial orientation, we say that we got to the same point, if not — to its twin point.

A quadratic differential q on a Riemann surface X defines a flat metric with holonomy group $\mathbb{Z}/2\mathbb{Z}$. Similarly to the previous case, there exists a canonical double cover $p : \hat{X} \rightarrow X$ such that the induced flat metric on \hat{X} has already trivial holonomy. In other words, the pull-back of q to \hat{X} is a square of a globally defined meromorphic 1-form $\hat{\omega}$, that is $p^*q = (\hat{\omega})^2$.

From now on we assume that the quadratic differential q has at most simple poles. The associated flat metric has cone angle $(k + 2)\pi$ at a zero of q of degree k . (This includes the case $k = -1$ corresponding to a simple pole, and $k = 0$ corresponding to a marked regular point.) Thus, holonomy of the flat metric along a short closed path going around a singularity is nontrivial if and only if it is a simple pole or a zero of odd degree. Simple poles and zeroes of odd degree are the only ramification points of the canonical double cover p .

Canonical double cover

Let us compute degrees of zeroes of the resulting 1-form $\hat{\omega}$. If P is a regular (non-branch) point on X , and the quadratic differential has a zero of degree $2k$ at P , then in an appropriate local coordinate w in a neighborhood of P it has the form $q = w^{2k} (dw)^2$. The same coordinate charts can be used on each of the two sheets of the cover, so $(\hat{\omega})^2 = p^*q = (w^k dw)^2$. Thus, there are two zeroes of the form $\hat{\omega}$ of degree k over each zero of q of even degree $2k$.

If q has a zero of odd degree, or a pole at a point P , i.e. $q = w^{2k-1} (dw)^2$ in a local coordinate in a neighborhood of P , then P is a branch point of the canonical cover. In a local coordinate w around the preimage of P on the cover \hat{X} , the ramified double cover has a form $w = u^2$. Thus, on the cover we have

$$p^*q = (u^2)^{2k-1} (d(u^2))^2 = u^{4k-2} (2udu)^2 = 4u^{4k} (du)^2 = (2u^{2k} du)^2.$$

We see that the form $\hat{\omega}$ has a single zero of degree k over each zero of q of odd degree $2k - 1$. In particular, simple poles of q (which correspond to $k = 0$) give rise to regular points of $\hat{\omega}$.

Example

Consider a quadratic differential

$$q = \frac{dz^2}{(z - z_1)(z - z_2)(z - z_3)(z - z_4)}$$

on \mathbb{CP}^1 , where we assume that $z_i \neq z_j$ for $i \neq j$. Clearly, q has simple poles at z_i , $i = 1, \dots, 4$. Note that the sum of degrees of zeroes and poles of a meromorphic quadratic differential on a surface of genus g (where we count degrees of poles with sign minus) equals $4g - 4$. Thus, q should have a regular point at ∞ . This can be verified by a direct computation. Let $u = \frac{1}{z}$ be a local coordinate in a neighborhood of $\infty \in \mathbb{CP}^1$. Then

$$q = \frac{\left(d\left(\frac{1}{u}\right)\right)^2}{\left(\frac{1}{u} - z_1\right)\left(\frac{1}{u} - z_2\right)\left(\frac{1}{u} - z_3\right)\left(\frac{1}{u} - z_4\right)}$$

Example

Consider a quadratic differential

$$q = \frac{dz^2}{(z - z_1)(z - z_2)(z - z_3)(z - z_4)}$$

on \mathbb{CP}^1 , where we assume that $z_i \neq z_j$ for $i \neq j$. Clearly, q has simple poles at z_i , $i = 1, \dots, 4$. Note that the sum of degrees of zeroes and poles of a meromorphic quadratic differential on a surface of genus g (where we count degrees of poles with sign minus) equals $4g - 4$. Thus, q should have a regular point at ∞ . This can be verified by a direct computation. Let $u = \frac{1}{z}$ be a local coordinate in a neighborhood of $\infty \in \mathbb{CP}^1$. Then

$$q = \frac{\left(d\left(\frac{1}{u}\right)\right)^2}{\left(\frac{1}{u} - z_1\right)\left(\frac{1}{u} - z_2\right)\left(\frac{1}{u} - z_3\right)\left(\frac{1}{u} - z_4\right)} = \frac{\left(\frac{-du}{u^2}\right)^2}{\frac{1}{u^4}(1 - uz_1)\dots(1 - uz_4)}.$$

Example

Consider a quadratic differential

$$q = \frac{dz^2}{(z - z_1)(z - z_2)(z - z_3)(z - z_4)}$$

on \mathbb{CP}^1 , where we assume that $z_i \neq z_j$ for $i \neq j$. Clearly, q has simple poles at z_i , $i = 1, \dots, 4$. Note that the sum of degrees of zeroes and poles of a meromorphic quadratic differential on a surface of genus g (where we count degrees of poles with sign minus) equals $4g - 4$. Thus, q should have a regular point at ∞ . This can be verified by a direct computation. Let $u = \frac{1}{z}$ be a local coordinate in a neighborhood of $\infty \in \mathbb{CP}^1$. Then

$$q = \frac{\left(d\left(\frac{1}{u}\right)\right)^2}{\left(\frac{1}{u} - z_1\right)\left(\frac{1}{u} - z_2\right)\left(\frac{1}{u} - z_3\right)\left(\frac{1}{u} - z_4\right)} = \frac{(du)^2}{(1 - uz_1)\dots(1 - uz_4)}.$$

We see that $u = 0$ is a regular point of q .

The canonical double cover $p : \hat{X} \rightarrow \mathbb{CP}^1$ is ramified at z_1, \dots, z_4 . The associated holomorphic form $\hat{\omega}$ on the torus \hat{X} is everywhere nonzero.

Torus as a ramified double cover

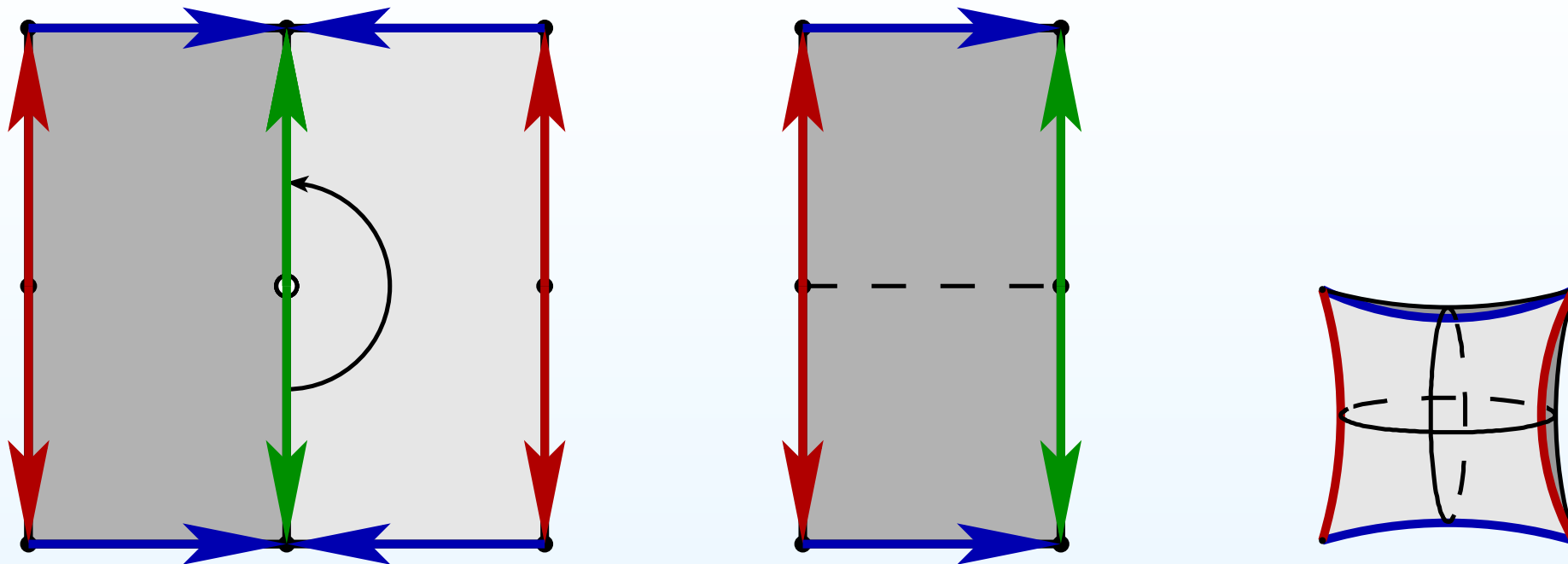

Consider a torus \mathbb{T}^2 glued from a unit square by identification of opposite sides by parallel translations. A central symmetry of the square acts as an involution τ of \mathbb{T}^2 . The left shaded region of the square provides a fundamental domain of the involution τ . The quotient of \mathbb{T}^2 by τ can be represented by identifications of sides of the fundamental domain as indicated in the picture; they correspond to folding the vertical shaded rectangle with respect to horizontal axes followed by identification of the boundary. We get a “pillow” $\mathbb{C}P^1$ as on the right picture and a double cover of $\mathbb{C}P^1$ by an elliptic curve \mathbb{T}^2 ramified at four points.

Elliptic surface

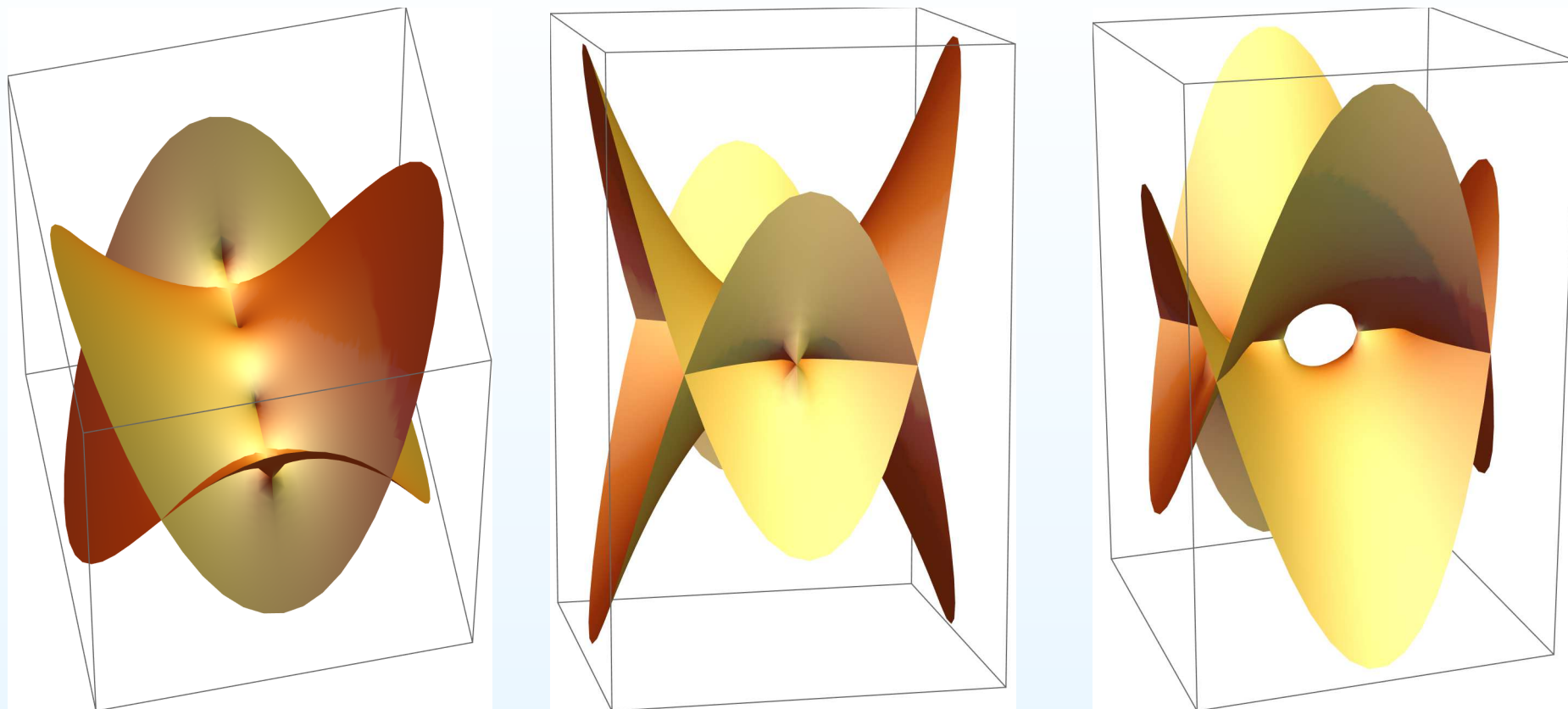

A schematic graphical representation of an elliptic surface

$$w^2 = (z - z_1)(z - z_2)(z - z_3)(z - z_4),$$

with real z_i . Pictures represent the same surface seen from different angles. It is not instant to recognize a topological torus in these pictures!

Families of hyperbolic surfaces

Consider a configuration of four distinct points on the Riemann sphere $\mathbb{C}P^1$. Using appropriate holomorphic automorphism of $\mathbb{C}P^1$ we can send three out of four points to 0 , 1 and ∞ . There is no more freedom: any further holomorphic automorphism of $\mathbb{C}P^1$ fixing 0 , 1 and ∞ is already the identity transformation. The remaining point serves as a complex parameter in the space $\mathcal{M}_{0,4}$ of configurations of four distinct points on $\mathbb{C}P^1$ (up to a holomorphic diffeomorphism).

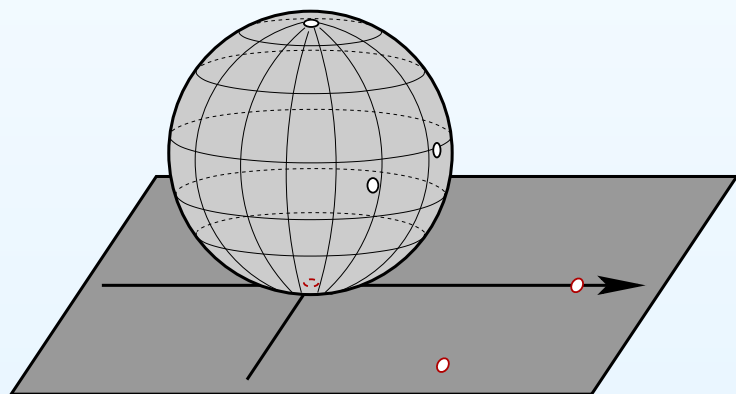

Families of hyperbolic surfaces

Consider a configuration of four distinct points on the Riemann sphere $\mathbb{C}P^1$. Using appropriate holomorphic automorphism of $\mathbb{C}P^1$ we can send three out of four points to 0 , 1 and ∞ . There is no more freedom: any further holomorphic automorphism of $\mathbb{C}P^1$ fixing 0 , 1 and ∞ is already the identity transformation. The remaining point serves as a complex parameter in the space $\mathcal{M}_{0,4}$ of configurations of four distinct points on $\mathbb{C}P^1$ (up to a holomorphic diffeomorphism).

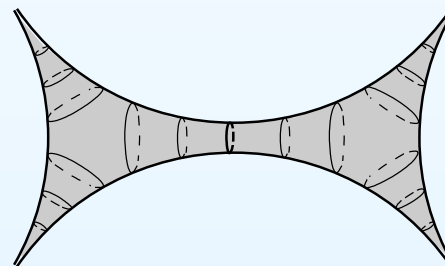
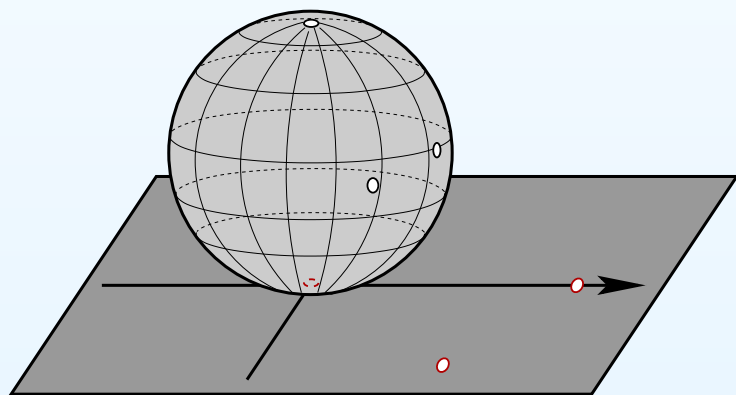

By the uniformization theorem, complex structures on a surface with marked points are in natural bijection with hyperbolic metrics of curvature -1 with cusps at the marked points, so the *moduli space* $\mathcal{M}_{0,4}$ can be also seen as the family of hyperbolic spheres with four cusps. Deforming the configuration of points we change the shape of the corresponding hyperbolic surface.

Families of hyperbolic surfaces

Consider a configuration of four distinct points on the Riemann sphere $\mathbb{C}P^1$. Using appropriate holomorphic automorphism of $\mathbb{C}P^1$ we can send three out of four points to 0 , 1 and ∞ . There is no more freedom: any further holomorphic automorphism of $\mathbb{C}P^1$ fixing 0 , 1 and ∞ is already the identity transformation. The remaining point serves as a complex parameter in the space $\mathcal{M}_{0,4}$ of configurations of four distinct points on $\mathbb{C}P^1$ (up to a holomorphic diffeomorphism).

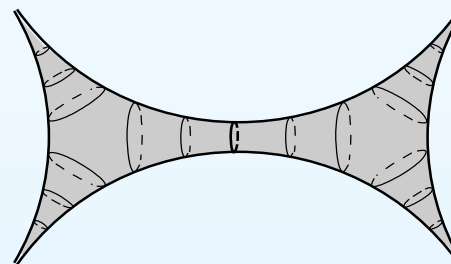
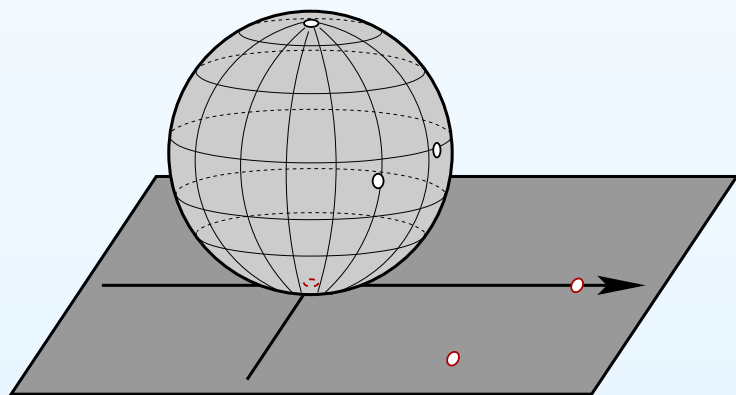

By the uniformization theorem, complex structures on a surface with marked points are in natural bijection with hyperbolic metrics of curvature -1 with cusps at the marked points, so the *moduli space* $\mathcal{M}_{0,4}$ can be also seen as the family of hyperbolic spheres with four cusps. Deforming the configuration of points we change the shape of the corresponding hyperbolic surface.

Families of hyperbolic surfaces

Consider a configuration of four distinct points on the Riemann sphere $\mathbb{C}P^1$. Using appropriate holomorphic automorphism of $\mathbb{C}P^1$ we can send three out of four points to 0 , 1 and ∞ . There is no more freedom: any further holomorphic automorphism of $\mathbb{C}P^1$ fixing 0 , 1 and ∞ is already the identity transformation. The remaining point serves as a complex parameter in the space $\mathcal{M}_{0,4}$ of configurations of four distinct points on $\mathbb{C}P^1$ (up to a holomorphic diffeomorphism).

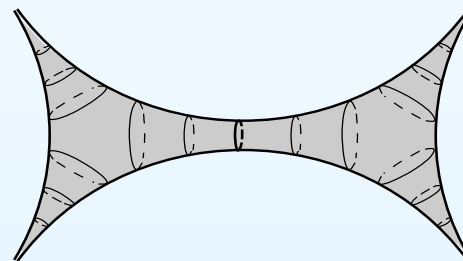
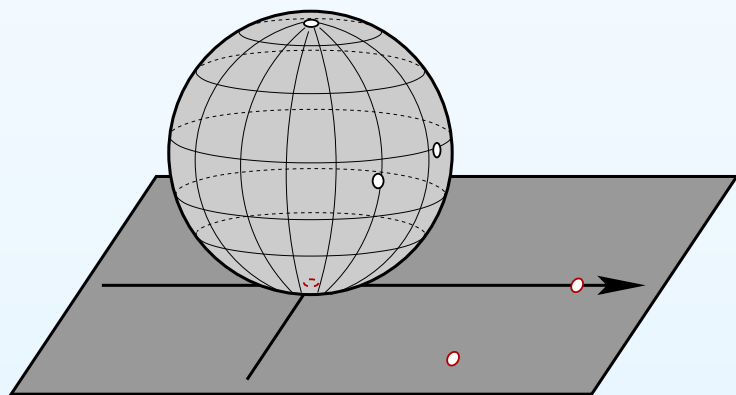

By the uniformization theorem, complex structures on a surface with marked points are in natural bijection with hyperbolic metrics of curvature -1 with cusps at the marked points, so the *moduli space* $\mathcal{M}_{0,4}$ can be also seen as the family of hyperbolic spheres with four cusps. Deforming the configuration of points we change the shape of the corresponding hyperbolic surface.

Families of hyperbolic surfaces

Consider a configuration of four distinct points on the Riemann sphere $\mathbb{C}P^1$. Using appropriate holomorphic automorphism of $\mathbb{C}P^1$ we can send three out of four points to 0 , 1 and ∞ . There is no more freedom: any further holomorphic automorphism of $\mathbb{C}P^1$ fixing 0 , 1 and ∞ is already the identity transformation. The remaining point serves as a complex parameter in the space $\mathcal{M}_{0,4}$ of configurations of four distinct points on $\mathbb{C}P^1$ (up to a holomorphic diffeomorphism).

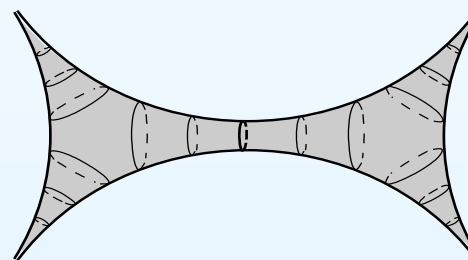
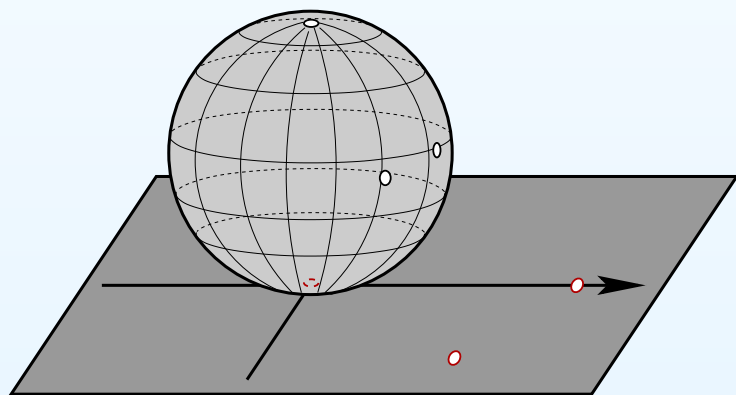

By the uniformization theorem, complex structures on a surface with marked points are in natural bijection with hyperbolic metrics of curvature -1 with cusps at the marked points, so the *moduli space* $\mathcal{M}_{0,4}$ can be also seen as the family of hyperbolic spheres with four cusps. Deforming the configuration of points we change the shape of the corresponding hyperbolic surface.

Families of hyperbolic surfaces

Consider a configuration of four distinct points on the Riemann sphere $\mathbb{C}P^1$. Using appropriate holomorphic automorphism of $\mathbb{C}P^1$ we can send three out of four points to 0 , 1 and ∞ . There is no more freedom: any further holomorphic automorphism of $\mathbb{C}P^1$ fixing 0 , 1 and ∞ is already the identity transformation. The remaining point serves as a complex parameter in the space $\mathcal{M}_{0,4}$ of configurations of four distinct points on $\mathbb{C}P^1$ (up to a holomorphic diffeomorphism).

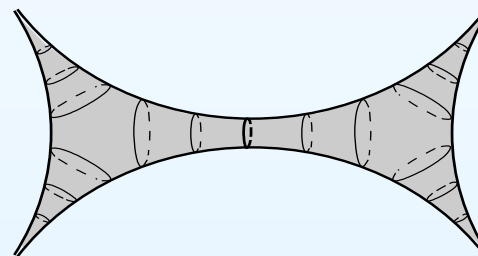
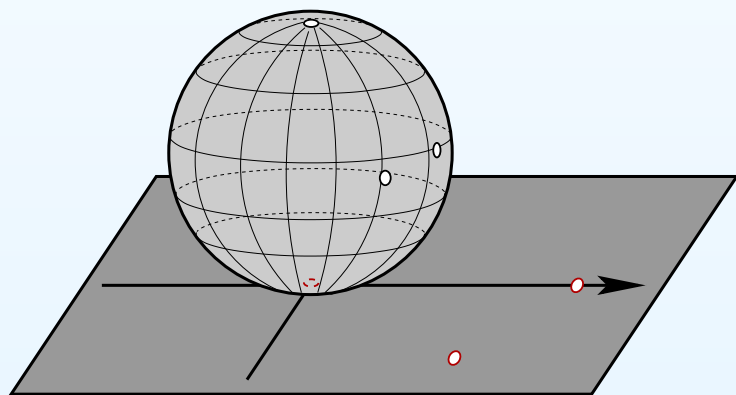

By the uniformization theorem, complex structures on a surface with marked points are in natural bijection with hyperbolic metrics of curvature -1 with cusps at the marked points, so the *moduli space* $\mathcal{M}_{0,4}$ can be also seen as the family of hyperbolic spheres with four cusps. Deforming the configuration of points we change the shape of the corresponding hyperbolic surface.

Families of hyperbolic surfaces

Consider a configuration of four distinct points on the Riemann sphere $\mathbb{C}P^1$. Using appropriate holomorphic automorphism of $\mathbb{C}P^1$ we can send three out of four points to 0 , 1 and ∞ . There is no more freedom: any further holomorphic automorphism of $\mathbb{C}P^1$ fixing 0 , 1 and ∞ is already the identity transformation. The remaining point serves as a complex parameter in the space $\mathcal{M}_{0,4}$ of configurations of four distinct points on $\mathbb{C}P^1$ (up to a holomorphic diffeomorphism).

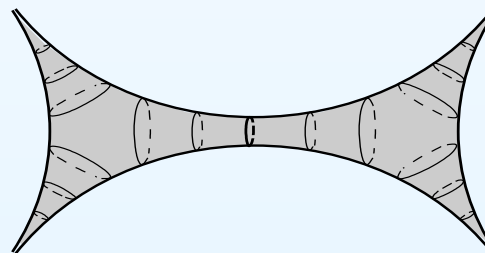
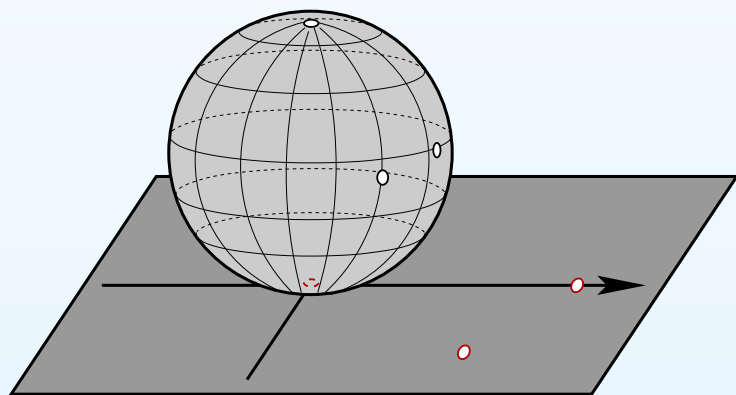

By the uniformization theorem, complex structures on a surface with marked points are in natural bijection with hyperbolic metrics of curvature -1 with cusps at the marked points, so the *moduli space* $\mathcal{M}_{0,4}$ can be also seen as the family of hyperbolic spheres with four cusps. Deforming the configuration of points we change the shape of the corresponding hyperbolic surface.

Families of hyperbolic surfaces

Consider a configuration of four distinct points on the Riemann sphere $\mathbb{C}P^1$. Using appropriate holomorphic automorphism of $\mathbb{C}P^1$ we can send three out of four points to 0 , 1 and ∞ . There is no more freedom: any further holomorphic automorphism of $\mathbb{C}P^1$ fixing 0 , 1 and ∞ is already the identity transformation. The remaining point serves as a complex parameter in the space $\mathcal{M}_{0,4}$ of configurations of four distinct points on $\mathbb{C}P^1$ (up to a holomorphic diffeomorphism).

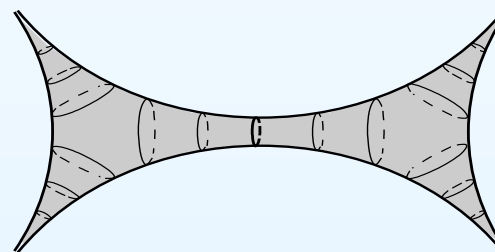
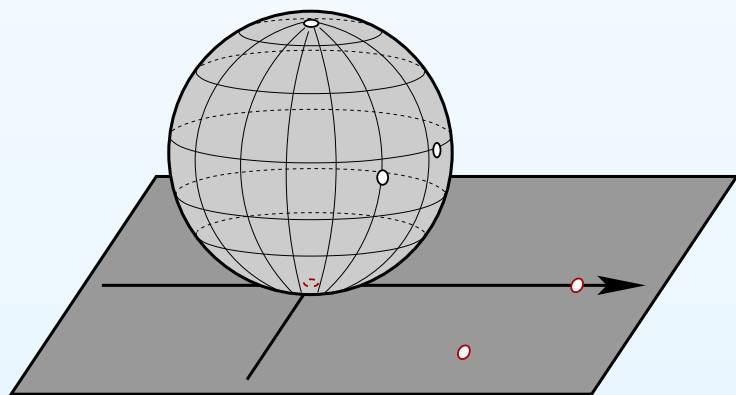

By the uniformization theorem, complex structures on a surface with marked points are in natural bijection with hyperbolic metrics of curvature -1 with cusps at the marked points, so the *moduli space* $\mathcal{M}_{0,4}$ can be also seen as the family of hyperbolic spheres with four cusps. Deforming the configuration of points we change the shape of the corresponding hyperbolic surface.

Families of hyperbolic surfaces

Consider a configuration of four distinct points on the Riemann sphere \mathbb{CP}^1 . Using appropriate holomorphic automorphism of \mathbb{CP}^1 we can send three out of four points to 0 , 1 and ∞ . There is no more freedom: any further holomorphic automorphism of \mathbb{CP}^1 fixing 0 , 1 and ∞ is already the identity transformation. The remaining point serves as a complex parameter in the space $\mathcal{M}_{0,4}$ of configurations of four distinct points on \mathbb{CP}^1 (up to a holomorphic diffeomorphism).

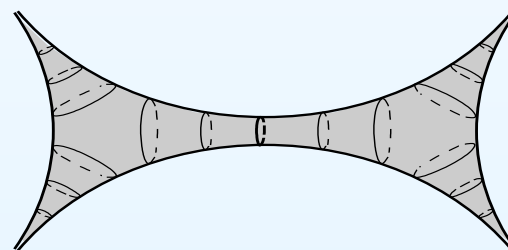
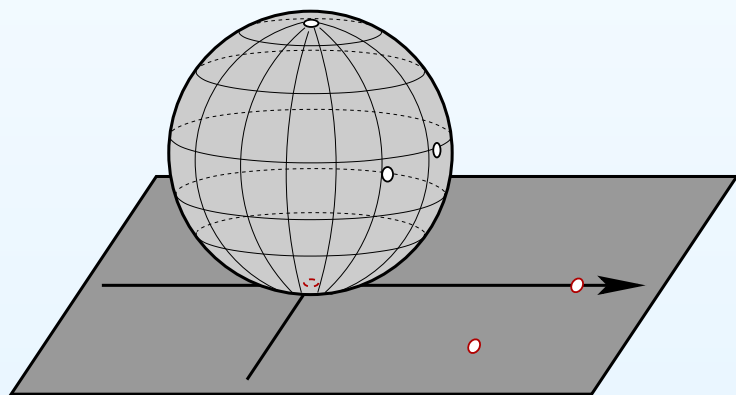

By the uniformization theorem, complex structures on a surface with marked points are in natural bijection with hyperbolic metrics of curvature -1 with cusps at the marked points, so the *moduli space* $\mathcal{M}_{0,4}$ can be also seen as the family of hyperbolic spheres with four cusps. Deforming the configuration of points we change the shape of the corresponding hyperbolic surface.

Families of hyperbolic surfaces

Consider a configuration of four distinct points on the Riemann sphere $\mathbb{C}P^1$. Using appropriate holomorphic automorphism of $\mathbb{C}P^1$ we can send three out of four points to 0 , 1 and ∞ . There is no more freedom: any further holomorphic automorphism of $\mathbb{C}P^1$ fixing 0 , 1 and ∞ is already the identity transformation. The remaining point serves as a complex parameter in the space $\mathcal{M}_{0,4}$ of configurations of four distinct points on $\mathbb{C}P^1$ (up to a holomorphic diffeomorphism).

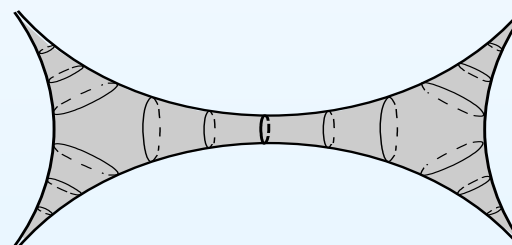
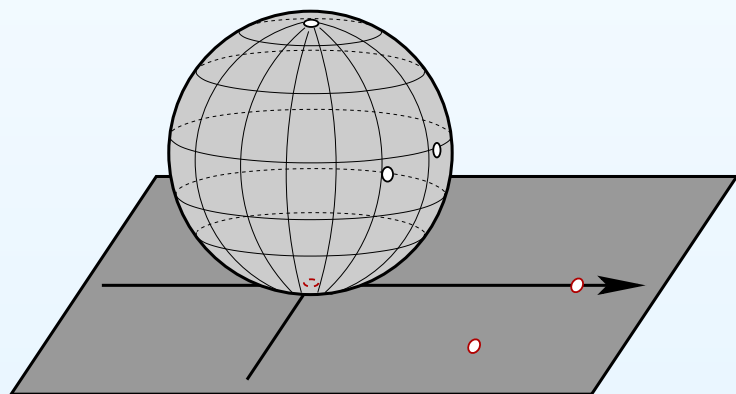

By the uniformization theorem, complex structures on a surface with marked points are in natural bijection with hyperbolic metrics of curvature -1 with cusps at the marked points, so the *moduli space* $\mathcal{M}_{0,4}$ can be also seen as the family of hyperbolic spheres with four cusps. Deforming the configuration of points we change the shape of the corresponding hyperbolic surface.

Families of hyperbolic surfaces

Consider a configuration of four distinct points on the Riemann sphere $\mathbb{C}P^1$. Using appropriate holomorphic automorphism of $\mathbb{C}P^1$ we can send three out of four points to 0 , 1 and ∞ . There is no more freedom: any further holomorphic automorphism of $\mathbb{C}P^1$ fixing 0 , 1 and ∞ is already the identity transformation. The remaining point serves as a complex parameter in the space $\mathcal{M}_{0,4}$ of configurations of four distinct points on $\mathbb{C}P^1$ (up to a holomorphic diffeomorphism).

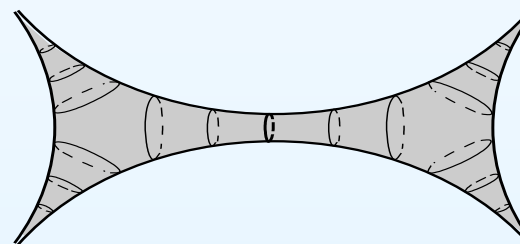
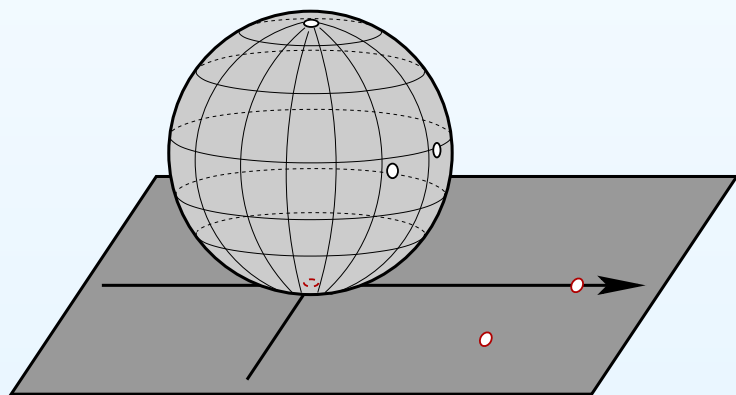

By the uniformization theorem, complex structures on a surface with marked points are in natural bijection with hyperbolic metrics of curvature -1 with cusps at the marked points, so the *moduli space* $\mathcal{M}_{0,4}$ can be also seen as the family of hyperbolic spheres with four cusps. Deforming the configuration of points we change the shape of the corresponding hyperbolic surface.

Families of hyperbolic surfaces

Consider a configuration of four distinct points on the Riemann sphere $\mathbb{C}P^1$. Using appropriate holomorphic automorphism of $\mathbb{C}P^1$ we can send three out of four points to 0 , 1 and ∞ . There is no more freedom: any further holomorphic automorphism of $\mathbb{C}P^1$ fixing 0 , 1 and ∞ is already the identity transformation. The remaining point serves as a complex parameter in the space $\mathcal{M}_{0,4}$ of configurations of four distinct points on $\mathbb{C}P^1$ (up to a holomorphic diffeomorphism).

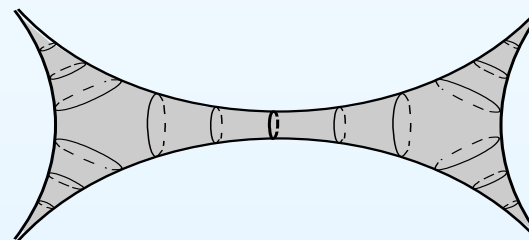
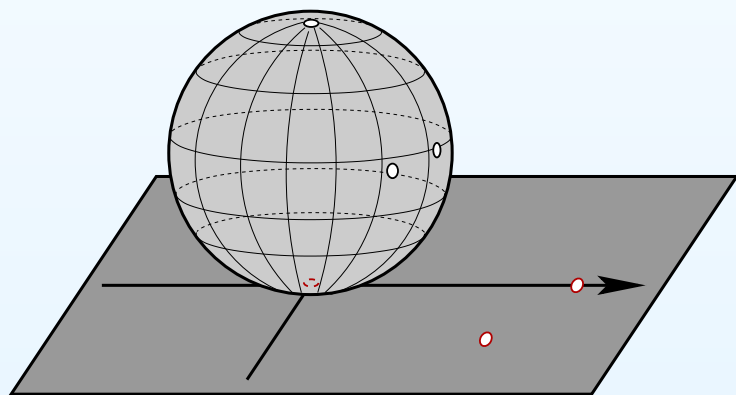

By the uniformization theorem, complex structures on a surface with marked points are in natural bijection with hyperbolic metrics of curvature -1 with cusps at the marked points, so the *moduli space* $\mathcal{M}_{0,4}$ can be also seen as the family of hyperbolic spheres with four cusps. Deforming the configuration of points we change the shape of the corresponding hyperbolic surface.

Families of hyperbolic surfaces

Consider a configuration of four distinct points on the Riemann sphere $\mathbb{C}P^1$. Using appropriate holomorphic automorphism of $\mathbb{C}P^1$ we can send three out of four points to 0 , 1 and ∞ . There is no more freedom: any further holomorphic automorphism of $\mathbb{C}P^1$ fixing 0 , 1 and ∞ is already the identity transformation. The remaining point serves as a complex parameter in the space $\mathcal{M}_{0,4}$ of configurations of four distinct points on $\mathbb{C}P^1$ (up to a holomorphic diffeomorphism).

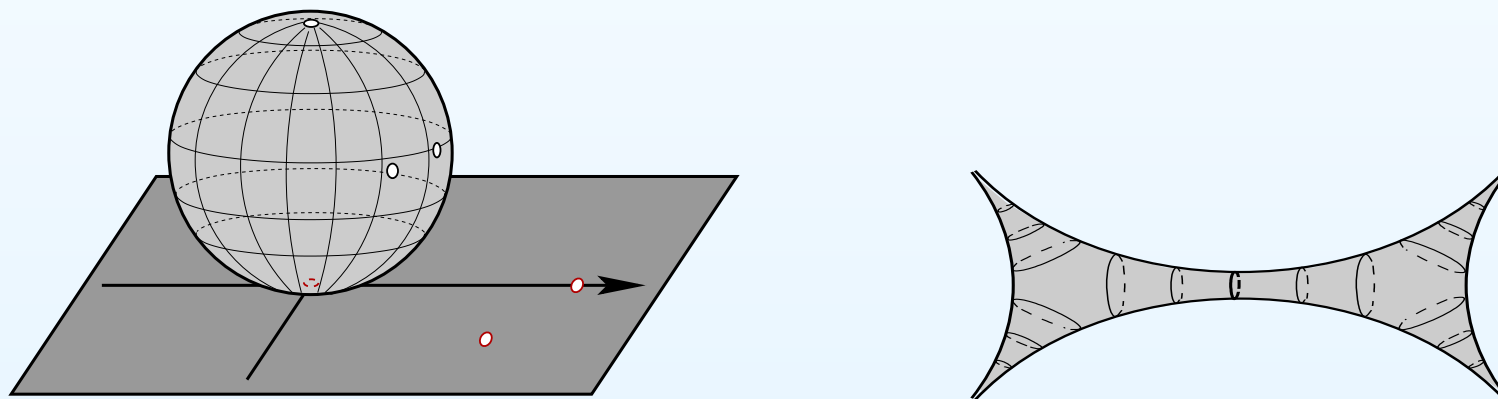

By the uniformization theorem, complex structures on a surface with marked points are in natural bijection with hyperbolic metrics of curvature -1 with cusps at the marked points, so the *moduli space* $\mathcal{M}_{0,4}$ can be also seen as the family of hyperbolic spheres with four cusps. Deforming the configuration of points we change the shape of the corresponding hyperbolic surface.

Ramified covers

Hyperelliptic surfaces

Quadratic differentials
and holomorphic
1-forms

Cyclic covers

- Cyclic covers
- Ramification profile.
Monodromy
- Pillow metric on \mathbb{CP}^1
- Holonomy of the
metric on the base and
on the cover
- Combinatorics of a
square-tiled cyclic cover
- Square-tiling of
 $M_6(1, 1, 1, 3)$:
answer

Relative homology.
Poincaré duality.
Intersection number

Cyclic covers

Cyclic covers

Consider an integer $N > 1$ and a 4-tuple of integers (a_1, \dots, a_4) satisfying:

$$0 < a_i \leq N; \quad \gcd(N, a_1, \dots, a_4) = 1; \quad \sum a_i \equiv 0 \pmod{N}.$$

Let $z_1, z_2, z_3, z_4 \in \mathbb{C}$ be four distinct points. Above conditions imply that, possibly after a desingularization, a Riemann surface $M_N(a_1, a_2, a_3, a_4)$ defined by

$$w^N = (z - z_1)^{a_1} (z - z_2)^{a_2} (z - z_3)^{a_3} (z - z_4)^{a_4}$$

is closed, connected and nonsingular. By construction, $M_N(a_1, a_2, a_3, a_4)$ is a ramified cover over the Riemann sphere \mathbb{CP}^1 branched over the points z_1, \dots, z_4 and over no other points. The condition on \gcd is a necessary and sufficient condition of connectedness of the resulting cyclic cover. The third condition implies that there is no branching at infinity.

A group of deck transformations of this cover is the cyclic group $\mathbb{Z}/N\mathbb{Z}$ with a generator $T : M \rightarrow M$ given by $T(z, w) = (z, \zeta w)$, where ζ is a primitive N th root of unity, $\zeta^N = 1$. By a *cyclic cover* we call a Riemann surface $M_N(a_1, \dots, a_4)$, with parameters N, a_1, \dots, a_4 .

Ramification profile of a cyclic cover. Monodromy representation

Let σ_i be a contour on the sphere going around z_i in the positive direction and not encircling other branch points. The paths $\sigma_i, i = 1, 2, 3$ generate the fundamental group of the sphere punctured at the four ramification points.

Test question. Why only three loops and not four? What is the fundamental group of a four-punctured sphere?

By lifting the loop σ_i to a path on the cover which starts at the point (w, z) , we land at the point $(\zeta^{a_i} w, z)$, where ζ is the primitive N th root of unity. Thus we get the following representation of the fundamental group of the punctured sphere in the cyclic group $\mathbb{Z}/N\mathbb{Z}$ of deck transformations:

$$\text{Deck} : \sigma_i \mapsto a_i \in \mathbb{Z}/N\mathbb{Z}$$

This observation implies that the Riemann surface $M_N(a_1, a_2, a_3, a_4)$ has $\gcd(N, a_i)$ *ramification points* over each *branch point* $z_i \in \mathbb{P}^1(\mathbb{C})$, where $i = 1, \dots, 4$, on the base sphere. Each ramification point has degree $N / \gcd(N, a_i)$.

Excercise. Using the Riemann–Hurwitz formula compute the genus of $M_N(a_1, a_2, a_3, a_4)$.

Pillow metric on $\mathbb{C}P^1$

A meromorphic quadratic differential $q(z)(dz)^2$ on a Riemann surface defines a flat metric $|q(z)|$ with conical singularities at zeroes and poles of q . The metric has finite area if and only if all the poles of q (if any) are simple. A meromorphic quadratic differential q_0 on $\mathbb{C}P^1$ of the form

$$q_0 := \frac{c_0 \cdot (dz)^2}{(z - z_1)(z - z_2)(z - z_3)(z - z_4)}, \quad \text{where } c_0 \neq 0$$

defines a structure of a flat “pillow” on $\mathbb{C}P^1$. One can choose c_0, z_1, z_2, z_3, z_4 in such a way that the parallelogram gets a shape of a unit square with vertical and horizontal sides.

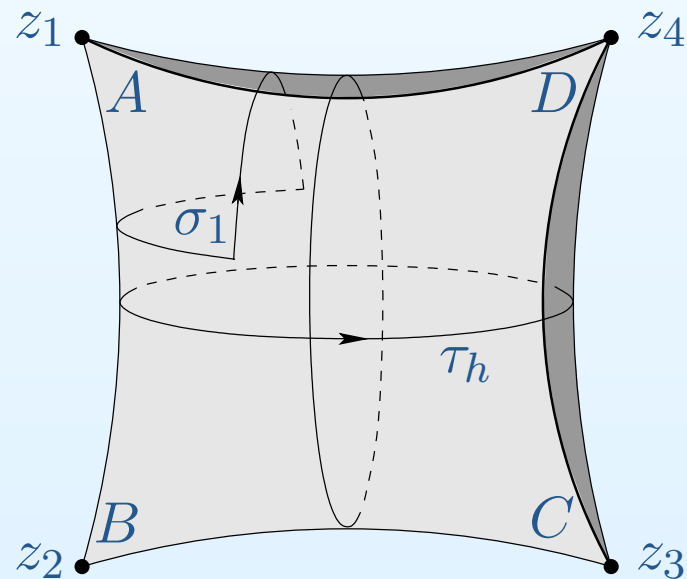

Holonomy of the metric on the base and on the cover

Since the cone angle at each cone singularity of the underlying “flat sphere” is π (no matter whether it is glued from squares or not), a parallel transport along each loop σ_i around a “corner” P_i of the pillow brings a tangent vector \vec{v} to $-\vec{v}$. Hence,

$$\text{Hol} : \sigma_i \mapsto 1 \in \mathbb{Z}/2\mathbb{Z}$$

for the generators σ_i of $\pi_1(\mathbb{CP}^1 \setminus P_1, P_2, P_3, P_4, P)$.

The induced flat metric on $M_N(a_1, a_2, a_3, a_4)$ has $\gcd(N, a_i)$ conical points over P_i ; each conical point has cone angle $(N/\gcd(N, a_i))\pi$.

Let \hat{P} be a regular point of the cover p , so that $p(\hat{P}) = P \neq P_i, i = 1, \dots, 4$. Since the metric on $M_N(a_1, a_2, a_3, a_4)$ is induced from the metric on the sphere, the holonomy representation

$$\widehat{\text{Hol}} : \pi_1(M_N(a_1, a_2, a_3, a_4), \hat{P}) \rightarrow \mathbb{Z}/2\mathbb{Z}$$

of the fundamental group of the cover factors through the one of the sphere:

$$\pi_1(M_N(a_1, a_2, a_3, a_4), \hat{P}) \rightarrow \pi_1(\mathbb{CP}^1 \setminus P_1, P_2, P_3, P_4, P) \rightarrow \mathbb{Z}/2\mathbb{Z}.$$

Combinatorics of a square-tiled cyclic cover

We have represented the base \mathbb{CP}^1 of the cover as a “pillow” glued from two unit squares. Since the cover $p : M_N(a_1, a_2, a_3, a_4) \rightarrow \mathbb{CP}^1$ has degree N , the cyclic cover gets tiled with $2N$ squares. We associate the letters A, B, C, D to the four corners of the pillow respectively. We also associate the corresponding letters to the corners of each square on the surface upstairs.

Paint one of the faces of our pillow in white, and the other one in black. Lift this coloring to the cover. Choose some white square S_0 on the cover, and associate the number 0 to it. Take a black square adjacent to the side $[CD]$ of S_0 , and associate the number 1 to it. Acting by deck transformations we associate to a white square $T^k(S_0)$ the number $2k$, and to a black square $T^k(S_1)$ the number $2k + 1$. As usual, k is taken modulo N , so we may assume that $0 \leq k < N$.

Consider a lift of a closed path σ_j around the corner number j on the pillow to the cover. The endpoint of the lifted path is the image of the action of T^{a_j} on the starting point of the lifted path. Hence, starting at a square number j and “turning around a corner” number k on $M_N(a_1, a_2, a_3, a_4)$ in the positive (i.e. in the counterclockwise) direction we get to a square number $j + 2a_k \pmod{2N}$.

Combinatorics of a square-tiled cyclic cover

A monodromy along a horizontal path τ_h following the equator of the pillow in the East direction acts as $T^{a_1+a_4} = T^{-(a_2+a_3)}$. Hence, “moving two squares to the right” on the cover we get from a square number j to a square number $j + 2(a_1 + a_4)$, if vertices B and C are at the bottom of the squares, and to a square number $j - 2(a_1 + a_4)$, if vertices B and C are on top of the squares.

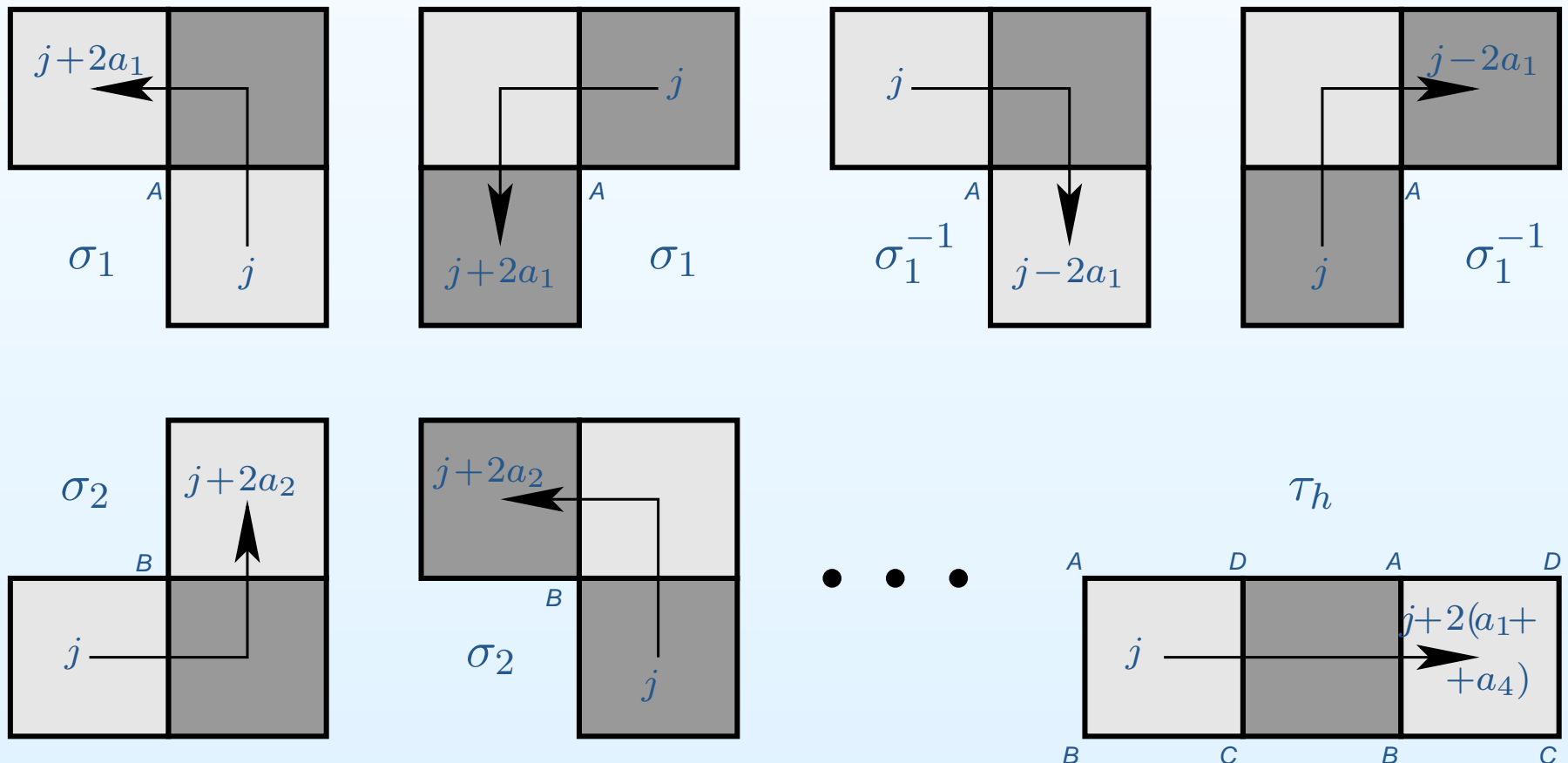

Square-tiling of $M_6(1, 1, 1, 3)$: construction

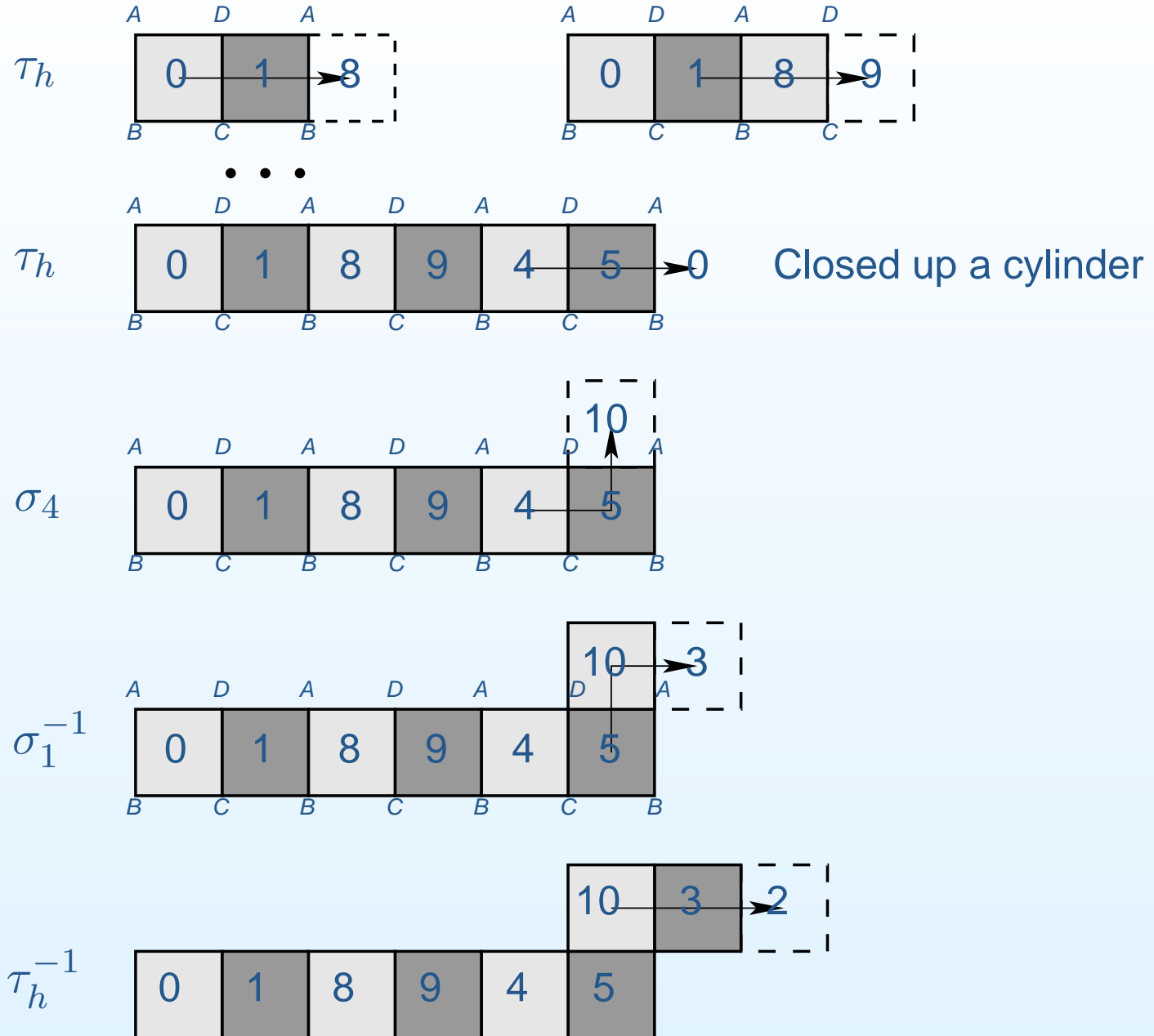

Square-tiling of $M_6(1, 1, 1, 3)$: answer

As a result we get the following square-tiling of $M_6(1, 1, 1, 3)$, where the exponents $\{1, 1, 1, 3\}$ are represented by vertices $\{A, B, C, D\}$ respectively.

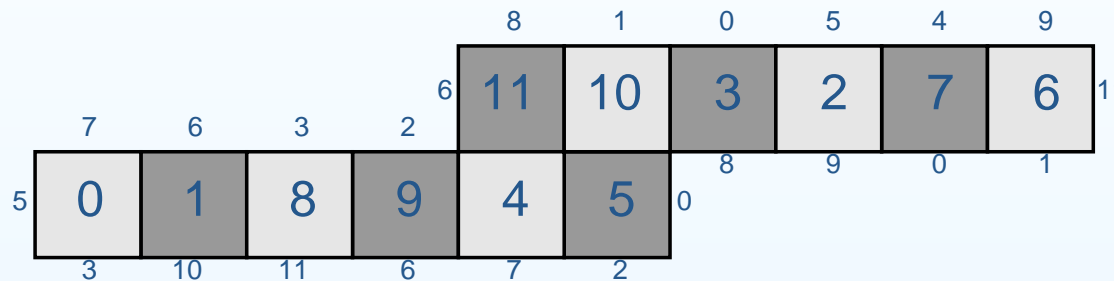

Note that by moving two squares to the right in the first row (say, $0 \longrightarrow 8$) we apply τ_h , while by moving two squares to the right in the second row (say, $10 \longrightarrow 2$) we apply τ_h^{-1} .

Excercise. Construct analogous square tiling for $M_4(1, 3, 2, 2)$.

Ramified covers

Hyperelliptic surfaces

Quadratic differentials
and holomorphic
1-forms

Cyclic covers

Relative homology.

Poincaré duality.

Intersection number

- Homology, cohomology
- Relative homology
- Exact sequence of a pair
- Stokes formula
- Idea of Poincaré duality
- Intersection number
- Exercise
- Period coordinates

Relative homology. Poincaré duality. Intersection number

Homology, cohomology

Sometimes we get a natural sequence of vector spaces (groups, ...) called “chains” related by linear transformations ∂ satisfying the relation $\partial^2 = 0$:

$$\dots \xrightarrow{\partial_{k+2}} C_{k+1} \xrightarrow{\partial_{k+1}} C_k \xrightarrow{\partial_k} C_{k-1} \xrightarrow{\partial_{k-1}} \dots \xrightarrow{\partial_0} 0.$$

The condition $\partial \circ \partial = 0$ implies that $\text{Im}(\partial_{k+1}) \subseteq \text{Ker}(\partial_k)$, and one defines *homology* of the above *chain complex* as $H_k := \text{Ker}(\partial_k) / \text{Im}(\partial_{k+1})$.

For example one can define *singular homology* of a topological space (which does not have anything singular) and a cell homology of a CW-complex (and prove that they, actually, coincide).

Considering linear functions on vector spaces C_k and induced maps of the resulting dual vector spaces C^k ones gets a co-chain complex

$$\dots \xleftarrow{d} C^{k+1} \xleftarrow{d} C^k \xleftarrow{d} C^{k-1} \xleftarrow{d} \dots \xleftarrow{d} 0.$$

The relation $\partial \circ \partial = 0$ valid for any k implies analogous relation $d \circ d = 0$, and we can define the *cohomology*

$$H^k := \text{Ker}(C^k \xrightarrow{d} C^{k+1}) / \text{Im}(C^{k-1} \xrightarrow{d} C^k),$$

as *de Rham cohomology* of a complex of differential forms on a manifold.

Relative homology

Let $Y \subset X$ be topological spaces such that $\overline{Y} = Y$. For singular homology we get an induced inclusion $C_k(Y) \subset C_k(X)$ for every k . Define *relative chains* as $C_k(X, Y) \stackrel{\text{def}}{=} C_k(X)/C_k(Y)$. We denote an induced map $C_k(X, Y) \rightarrow C_{k-1}(X, Y)$ by the same symbol ∂_k . It is immediate to check that we still have $\text{Im}(\partial_{k+1}) \subseteq \text{Ker}(\partial_k)$, which allows to define *relative homology* as $H_k(X, Y) := \text{Ker}(\partial_k) / \text{Im}(\partial_{k+1})$.

- The inclusion $i : Y \hookrightarrow X$ induces a map $i_* : H_k(Y) \rightarrow H_k(X)$.
- An absolute *cycle*, i.e. an element of $H_k(X)$, naturally defines a *relative cycle*, so we get a map $\pi : H_k(X) \rightarrow H_k(X, Y)$.
- Let z_k be a relative cycle, $z_k \in \text{Ker} \partial_k : C_k(X, Y) \rightarrow C_{k-1}(X, Y)$. Take its representative $\tilde{z}_k \in C_k(X)$. Then $\partial_k(\tilde{z}_k) \in C_{k-1}(Y)$ and, moreover, $\partial_k(\tilde{z}_k) \in \text{Ker} \partial_k : C_{k-1}(Y) \rightarrow C_{k-2}(Y)$. Thus, \tilde{z}_k defines an element of $H_{k-1}(Y)$.

Excercise. Verify that the resulting element of $H_{k-1}(Y)$ does not depend on a choice of the representative \tilde{z}_k of z_k .

Exact sequence of a pair

Theorem. The following sequence is exact

$$\begin{array}{ccccccc}
 & & & & & \dots & \\
 \xrightarrow{\partial_{k+1}} & H_k(Y) & \xrightarrow{i_*} & H_k(X) & \xrightarrow{\pi} & H_k(X, Y) & \xrightarrow{\partial_k} \\
 \xrightarrow{\partial_k} & H_{k-1}(Y) & \xrightarrow{i_*} & H_{k-1}(X) & \xrightarrow{\pi} & H_{k-1}(X, Y) & \xrightarrow{\partial_k} \\
 \xrightarrow{\partial_k} & \dots & & & & &
 \end{array}$$

i.e. for any two consecutive maps the image of the first one coincides with the kernel of the second one. This sequence is called the *exact sequence of a pair* (X, Y) .

Similar to the case of *absolute cochains* we can define a complex of *relative cochains* as linear functions on relative chains and define relative cohomology and an induced exact sequence of the pair (X, Y) for cohomology:

$$\begin{array}{ccccccc}
 \xleftarrow{d} & H^k(Y) & \xleftarrow{i^*} & H^k(X) & \xleftarrow{\pi^*} & H^k(X, Y) & \xleftarrow{d} \\
 \xleftarrow{d} & H^{k-1}(Y) & \xleftarrow{i^*} & H^{k-1}(X) & \xleftarrow{\pi^*} & H^{k-1}(X, Y) & \xleftarrow{d}
 \end{array}$$

Stokes formula

Theorem (Stokes formula). Let N^{k+1} be a $(k + 1)$ -dimensional smooth oriented submanifold with boundary of a smooth oriented manifold M . The boundary ∂N is a smooth k -dimensional submanifold, which inherits a natural orientation from N^{k+1} . Let $\omega \in \Omega^k(M)$ be a smooth k -differential form on M .

$$\int_{\partial N} \omega = \int_N d\omega .$$

A differential form ω is called *closed* if $d\omega = 0$ and *exact* if there exists a form ϕ such that $\omega = d\phi$. The Stokes formula shows that when ω is closed, we have $\int_{\partial N} \omega = 0$ and when ω is exact and K is a k -dimensional oriented submanifold without boundary (with empty boundary), then $\int_K \omega = 0$.

Idea of Poicaré duality

By definition, two distinct k -dimensional submanifolds K_1 and K_2 are *homologous* (i.e. define homologous k -cycles $[K_1]$ and $[K_2]$) if there exists a $(k + 1)$ -chain $[N]$ such that $\partial[N] = [K_1] - [K_2]$. Ignoring a discussion when and how we can realize the chain $[N]$ as a $(k + 1)$ -dimensional submanifold, we see that two k -dimensional submanifolds K_1 and K_2 are homologous when K_1 taken with its original orientation union with K_2 taken with the opposite orientation form an oriented boundary of an oriented submanifold N^{k+1} .

Cycles γ_1 and γ_2 are homologous but *not* freely homotopic to each other.

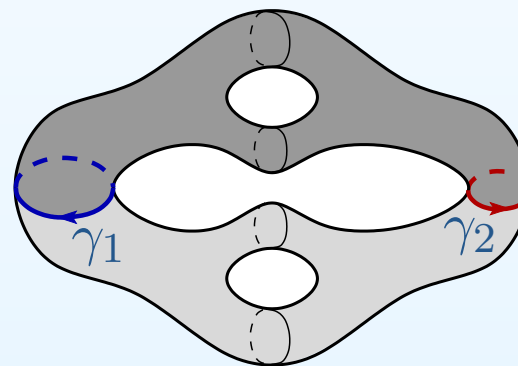

The Stokes formula implies that integrals of a closed k -form ω over K_1 and K_2 coincide, and integrals of an *exact* k -form $d\phi$ over K_1 and K_2 are null. We get a natural pairing between $H_k(M, \mathbb{R})$ and de Rham cohomology $H^k(M, \mathbb{R})$. *Poincaré duality* asserts that this pairing is nondegenerate (and justifies that cohomology can be seen as linear functions on homology).

Intersection number

Let γ_1, γ_2 be two smooth closed oriented curves on a smooth closed oriented surface. Suppose that the curves are in a *general position*, i.e. all their intersections x_j are transversal; let $\gamma_1 \cap \gamma_2 = \{x_1, \dots, x_k\}$. Define a *sign* $\text{sgn}(x_j)$ of an intersection x_j as 1 if an ordered frame $(\dot{\gamma}_1|_{x_j}, \dot{\gamma}_2|_{x_j})$ composed of tangent vectors to the curves has the orientation of the surface and as -1 otherwise. The *algebraic intersection number* $\gamma_1 \circ \gamma_2$ is defined as $\sum_{j=1}^k \text{sgn}(x_j)$. It instantly follows from the definition that $\gamma_1 \circ \gamma_2 = -\gamma_2 \circ \gamma_1$.

Lemma. *Intersection number $\gamma_1 \circ \gamma_2$ is invariant under free homotopy of γ_i .*

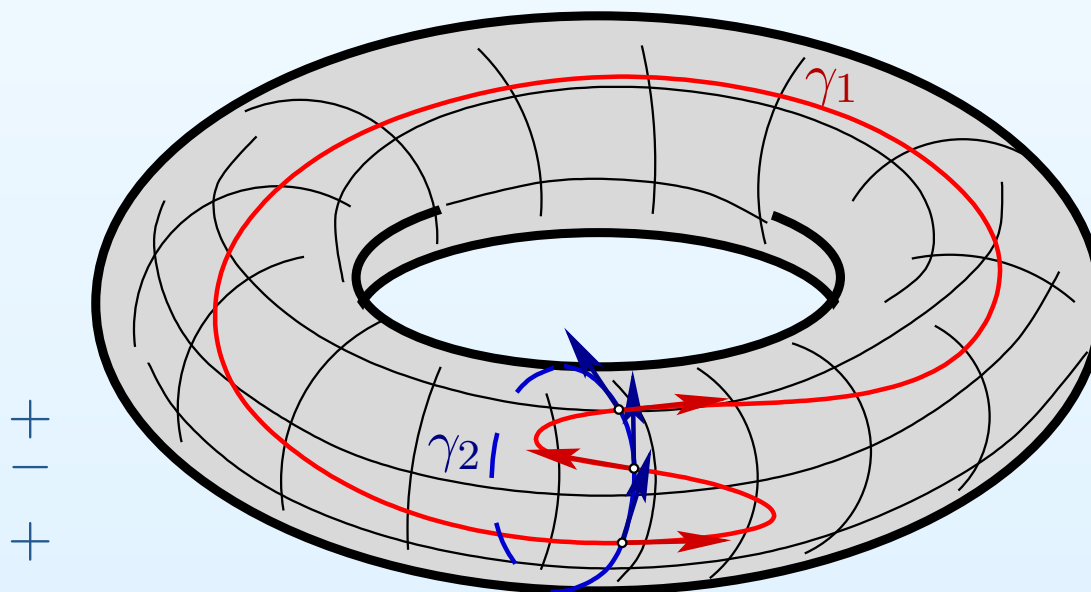

Intersection number

Let γ_1, γ_2 be two smooth closed oriented curves on a smooth closed oriented surface. Suppose that the curves are in a *general position*, i.e. all their intersections x_j are transversal; let $\gamma_1 \cap \gamma_2 = \{x_1, \dots, x_k\}$. Define a *sign* $\text{sgn}(x_j)$ of an intersection x_j as 1 if an ordered frame $(\dot{\gamma}_1|_{x_j}, \dot{\gamma}_2|_{x_j})$ composed of tangent vectors to the curves has the orientation of the surface and as -1 otherwise. The *algebraic intersection number* $\gamma_1 \circ \gamma_2$ is defined as $\sum_{j=1}^k \text{sgn}(x_j)$. It instantly follows from the definition that $\gamma_1 \circ \gamma_2 = -\gamma_2 \circ \gamma_1$.

Lemma. *Intersection number $\gamma_1 \circ \gamma_2$ is invariant under free homotopy of γ_i .*

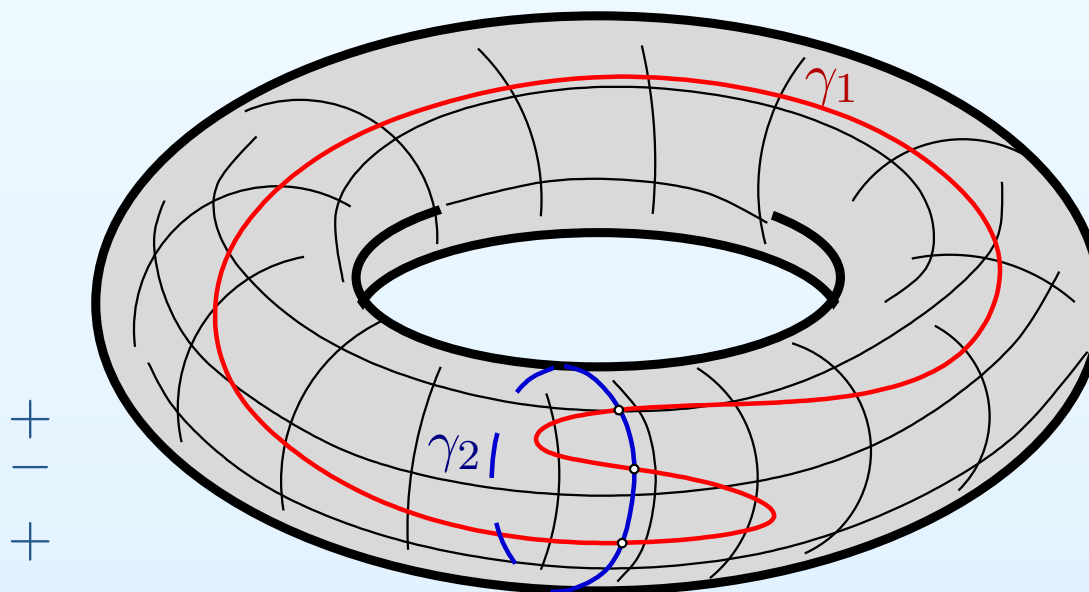

Intersection number

Let γ_1, γ_2 be two smooth closed oriented curves on a smooth closed oriented surface. Suppose that the curves are in a *general position*, i.e. all their intersections x_j are transversal; let $\gamma_1 \cap \gamma_2 = \{x_1, \dots, x_k\}$. Define a *sign* $\text{sgn}(x_j)$ of an intersection x_j as 1 if an ordered frame $(\dot{\gamma}_1|_{x_j}, \dot{\gamma}_2|_{x_j})$ composed of tangent vectors to the curves has the orientation of the surface and as -1 otherwise. The *algebraic intersection number* $\gamma_1 \circ \gamma_2$ is defined as $\sum_{j=1}^k \text{sgn}(x_j)$. It instantly follows from the definition that $\gamma_1 \circ \gamma_2 = -\gamma_2 \circ \gamma_1$.

Lemma. *Intersection number $\gamma_1 \circ \gamma_2$ is invariant under free homotopy of γ_i .*

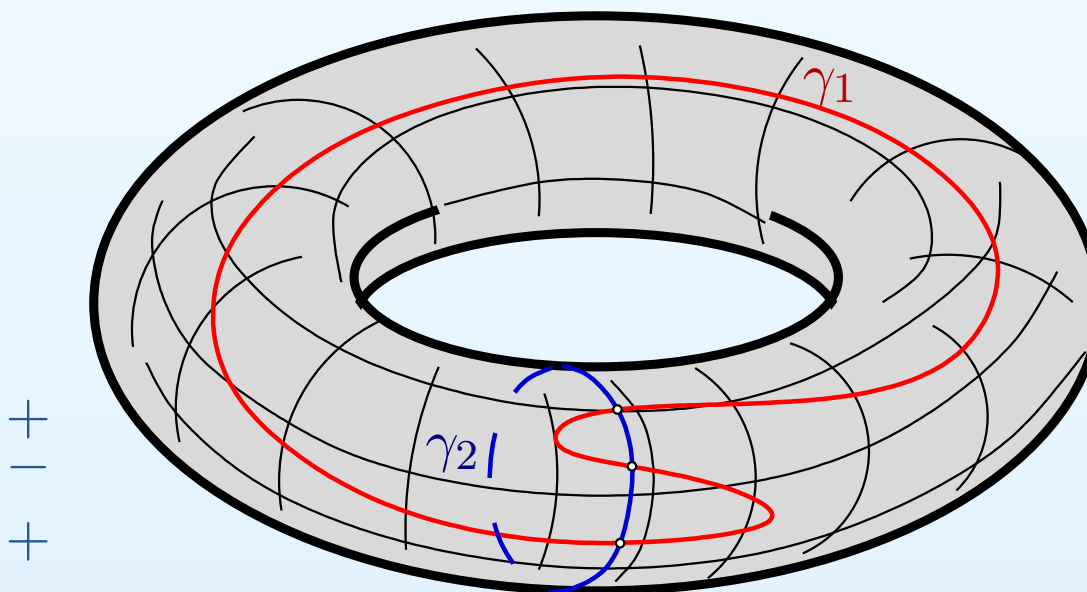

Intersection number

Let γ_1, γ_2 be two smooth closed oriented curves on a smooth closed oriented surface. Suppose that the curves are in a *general position*, i.e. all their intersections x_j are transversal; let $\gamma_1 \cap \gamma_2 = \{x_1, \dots, x_k\}$. Define a *sign* $\text{sgn}(x_j)$ of an intersection x_j as 1 if an ordered frame $(\dot{\gamma}_1|_{x_j}, \dot{\gamma}_2|_{x_j})$ composed of tangent vectors to the curves has the orientation of the surface and as -1 otherwise. The *algebraic intersection number* $\gamma_1 \circ \gamma_2$ is defined as $\sum_{j=1}^k \text{sgn}(x_j)$. It instantly follows from the definition that $\gamma_1 \circ \gamma_2 = -\gamma_2 \circ \gamma_1$.

Lemma. *Intersection number $\gamma_1 \circ \gamma_2$ is invariant under free homotopy of γ_i .*

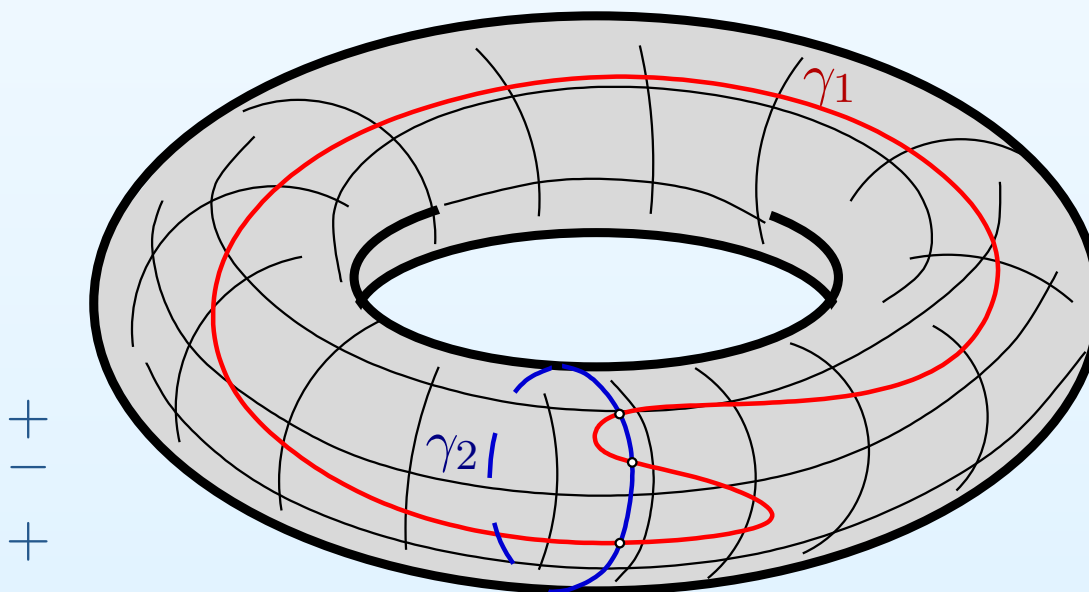

Intersection number

Let γ_1, γ_2 be two smooth closed oriented curves on a smooth closed oriented surface. Suppose that the curves are in a *general position*, i.e. all their intersections x_j are transversal; let $\gamma_1 \cap \gamma_2 = \{x_1, \dots, x_k\}$. Define a *sign* $\text{sgn}(x_j)$ of an intersection x_j as 1 if an ordered frame $(\dot{\gamma}_1|_{x_j}, \dot{\gamma}_2|_{x_j})$ composed of tangent vectors to the curves has the orientation of the surface and as -1 otherwise. The *algebraic intersection number* $\gamma_1 \circ \gamma_2$ is defined as $\sum_{j=1}^k \text{sgn}(x_j)$. It instantly follows from the definition that $\gamma_1 \circ \gamma_2 = -\gamma_2 \circ \gamma_1$.

Lemma. *Intersection number $\gamma_1 \circ \gamma_2$ is invariant under free homotopy of γ_i .*

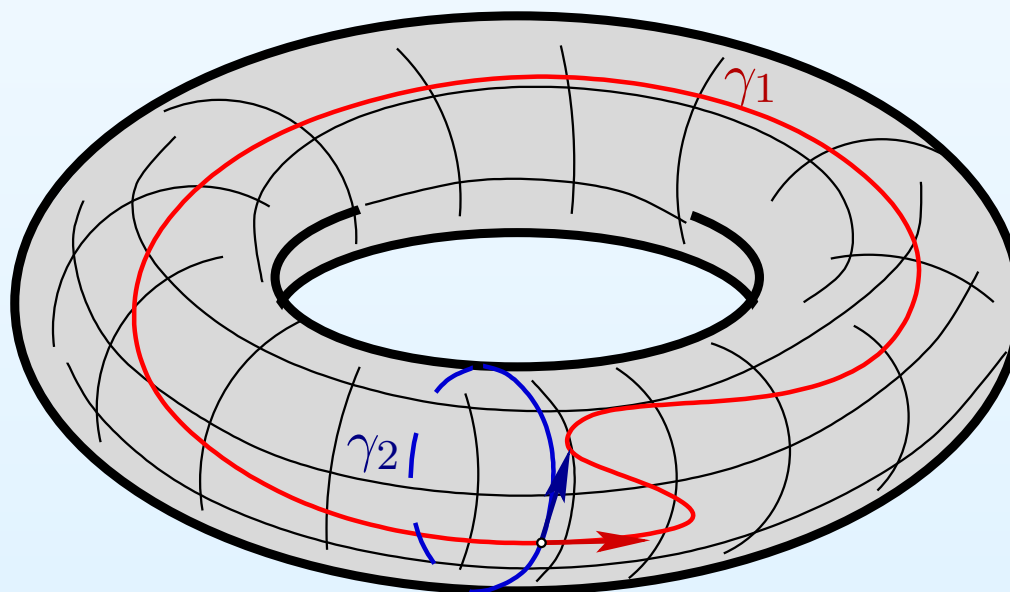

Intersection number

Actually, a much stronger statement is valid:

Theorem. *Intersection number $\gamma_1 \circ \gamma_2$ depends only on homology classes $[\gamma_1], [\gamma_2]$ of the curves. It defines a nondegenerate symplectic structure on the first homology of the surface.*

The notion of intersection number extends to closed oriented submanifolds P^p, Q^q of complementary dimensions $p + q = n$, where n is the dimension of the ambient oriented manifold M^n . Now we have $P \circ Q = (-1)^{pq} Q \circ P$. The intersection number is again completely determined by homology classes of P and Q (where this time we consider homology only with coefficients in $\mathbb{Q}, \mathbb{R}, \mathbb{C}$ to avoid torsion). It is known that the pairing is always nondegenerate, which provides a canonical way to identify cohomology $H^k(M^n)$ with homology $H_{n-k}(M^n)$. Values $\ell(c)$ of a k -cocycle ℓ on k -cycles c represented by closed oriented k -submanifolds $c = [N^k]$ are interpreted as an intersection numbers $\ell([N^k]) = N^k \circ L^{n-k}(\ell)$ with a fixed submanifold $L^{n-k}(\ell)$ representing the $(n - k)$ -cycle $[L^{n-k}]$ dual to the k -cocycle ℓ . This is the original approach of H. Poincaré to Poincaré duality and origin of the notion of *intersection theory*.

Symplectic structure in cohomology

Having two closed 1-forms ω_1, ω_2 on a smooth closed orientable surface S define a skew-symmetric pairing

$$\langle \omega_1, \omega_2 \rangle := \int_S \omega_1 \wedge \omega_2 .$$

Theorem. *The pairing $\langle \omega_1, \omega_2 \rangle$ depends only on cohomology classes $[\omega_1], [\omega_2]$ of the closed forms. It defines a nondegenerate symplectic structure on the first cohomology of the surface. Poincaré duality $D : H^1(S) \rightarrow H_1(S)$ respects the natural symplectic structures on homology and cohomology:*

$$\langle \omega_1, \omega_2 \rangle = (D[\omega_1]) \circ (D[\omega_2]) .$$

To verify the first assertion note that when ω_2 is closed we have

$$\int_S df \wedge \omega_2 = \int_S d(f\omega_2) = \int_{\partial S} f\omega_2 = 0$$

since the surface S does not have boundary, $\partial S = \emptyset$.

Exercise

- Check that the following two flat surfaces belong to the stratum $\mathcal{H}(4)$.

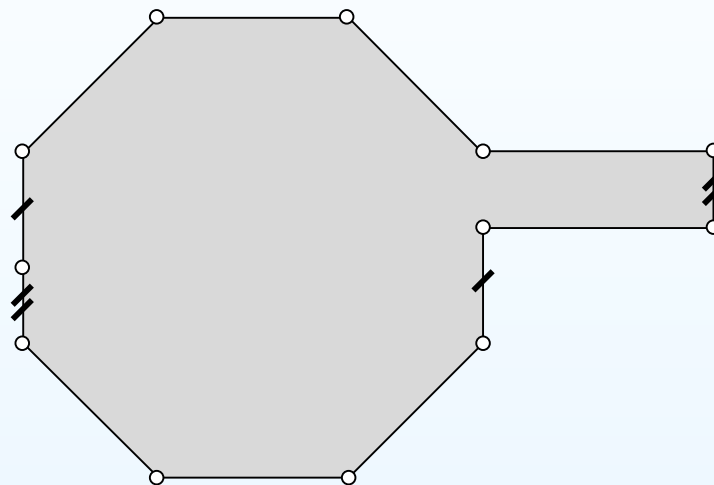
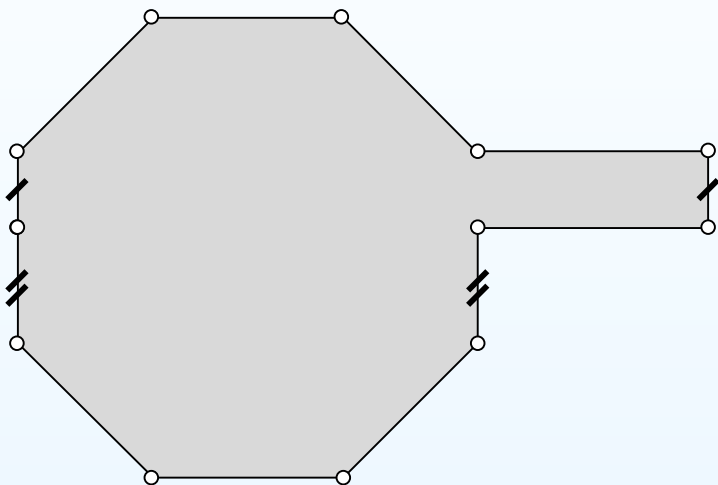

- Compute a matrix of intersection numbers between cycles representing the sides of the left polygon. Prove that these cycles form a basis in homology.
- Determine which of the two surfaces is hyperelliptic.
- Find the hyperelliptic involution of this surface in geometric terms. Find the Weierstrass points (the fixed points of the hyperelliptic involution). Check that there are $2g + 2$ such points.

Period coordinates

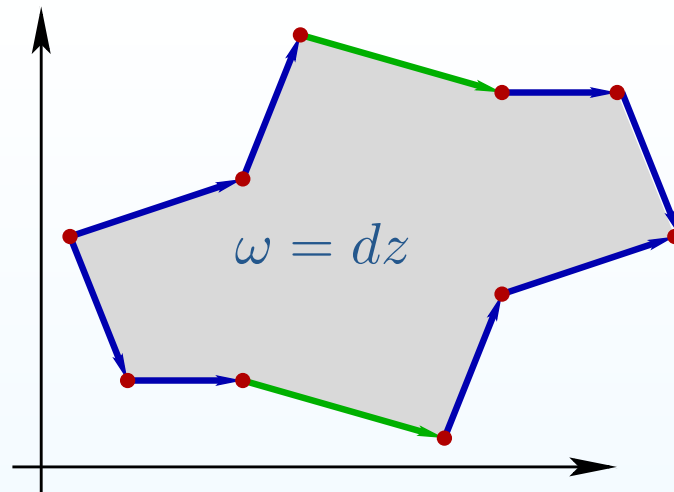
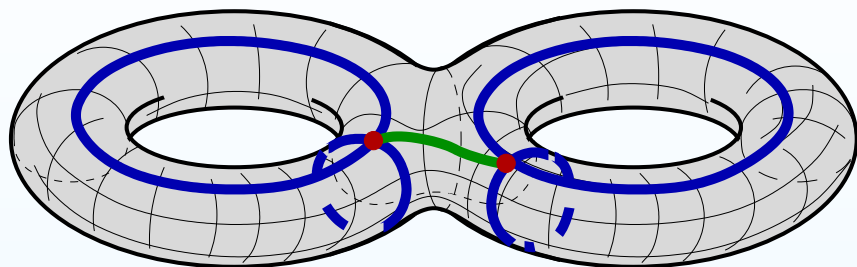

Identifying corresponding sides V_j of a polygon by parallel translations we get a Riemann surface X and a holomorphic 1-form ω on it, where $\omega = dz$ in coordinate z on the polygon. The sides V_j become lines on S with endpoints in the collection of points $Y = \{P_1, \dots, P_k\} \subset X$ coming from vertices of the polygon. Since $d\omega = 0$ it defines a relative homology class $[\omega] \in H^1(X, Y; \mathbb{C})$: the value of $[\omega]$ on a cycle c is given by $\int_\gamma \omega$, where $[\gamma] = c$ is any collection of paths representing c . It is easy to check that vectors V_j generate $H_1(X, Y; \mathbb{C})$. Considered as complex numbers, they represent integrals $\mathbb{C} \ni V_j = \int_{V_j} dz$ of ω over the corresponding relative cycles. Thus, the collection of vectors uniquely determines $[\omega] \in H^1(X, Y; \mathbb{C})$. Reciprocally, any cohomology class in $H^1(X, Y; \mathbb{C})$ sufficiently close to $[\omega]$ defines a collection of deformed integrals over paths V_j , and, hence a deformed polygon.