



भारतीय विज्ञान शिक्षा एवं अनुसंधान संस्थान बरहमपुर
Indian Institute of Science Education and Research Berhampur

Mathematics Online Seminar Series 2020

Linear recurrence sequences: part I

Michel Waldschmidt

Institut de Mathématiques de Jussieu — Sorbonne Université

<http://www.math.jussieu.fr/~michel.waldschmidt/>

Abstract

Linear recurrence sequences are ubiquitous. They occur in biology, economics, computer science (analysis of algorithms), digital signal processing. We give a survey of this subject, together with connections with linear combinations of powers, with powers of matrices and with linear differential equations.

This first part is devoted to examples : Fibonacci, Lucas, balancing numbers, Perrin, Padovan, Narayana.

Applications of linear recurrence sequences

Combinatorics

Elimination

Symmetric functions

Hypergeometric series

Language

Communication, shift registers

Finite difference equations

Logic

Approximation

Pseudo-random sequences

Applications of linear recurrence sequences

- Biology (Integrodifference equations, spatial ecology).
- Computer science (analysis of algorithms).
- Digital signal processing (infinite impulse response (IIR) digital filters).
- Economics (time series analysis).

https://en.wikipedia.org/wiki/Recurrence_relation

How many ancestors do we have ?

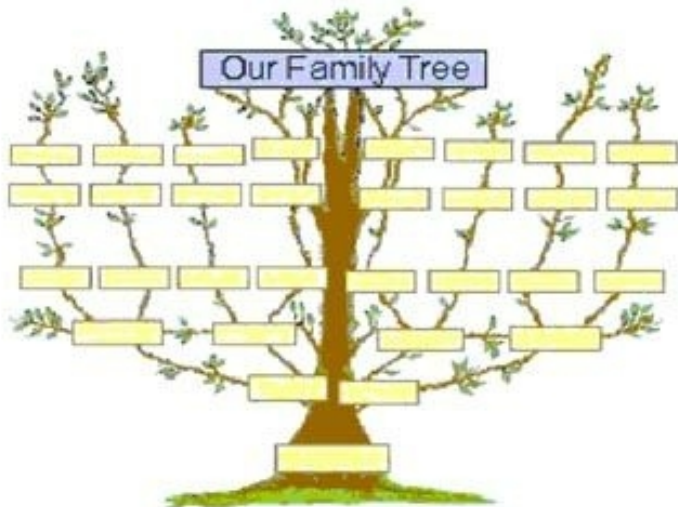

Geometric series

$$u_0 = 1, \quad u_{n+1} = 2u_n$$

How many ancestors do we have?

Sequence: 1, 2, 4, 8, 16 ...

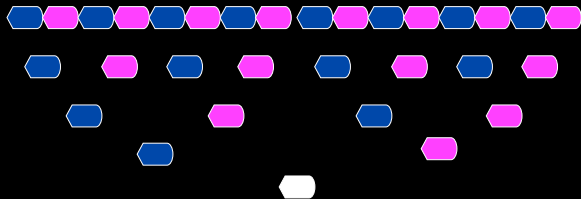

Bees genealogy

Male honeybees are born from unfertilized eggs. Female honeybees are born from fertilized eggs. Therefore males have only a mother, but females have both a mother and a father.

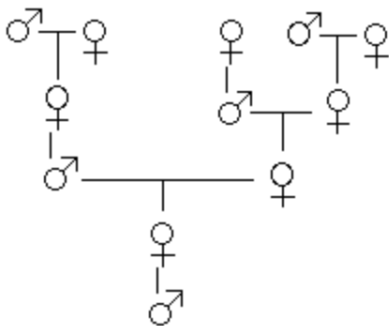

Genealogy of a male bee (bottom – up)

Number of bees :

1, 1, 2, 3, 5...

Number of females :

0, 1, 1, 2, 3...

Rule :

$$u_{n+2} = u_{n+1} + u_n.$$

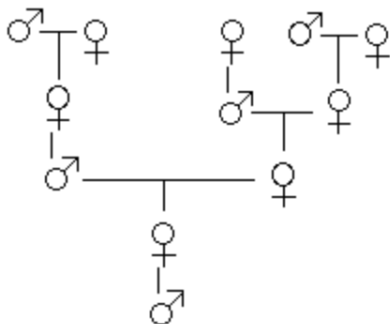

Bees genealogy $u_1 = 1, u_2 = 1, u_{n+2} = u_{n+1} + u_n$

Number of females at a given level =
total population at the previous level
Number of males at a given level =
number of females at the previous level

$$3 + 5 = 8$$



$$2 + 3 = 5$$

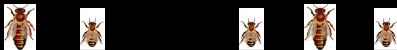

$$1 + 2 = 3$$



$$1 + 1 = 2$$

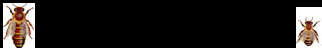

$$0 + 1 = 1$$



$$1 + 0 = 1$$



The Lamé Series



Gabriel Lamé
1795 – 1870



Edouard Lucas
1842 - 1891

In 1844 the sequence

$0, 1, 1, 2, 3, 5, 8, 13, 21, 34, 55, 89, 144, 233, \dots$

was referred to as the Lamé series, because Gabriel Lamé used it to give an upper bound for the number of steps in the Euclidean algorithm for the gcd.

On a trip to Italy in 1876 Edouard Lucas found them in a copy of the Liber Abbaci of Leonardo da Pisa.

Leonardo Pisano (Fibonacci)

Fibonacci sequence $(F_n)_{n \geq 0}$,

0, 1, 1, 2, 3, 5, 8, 13, 21,

34, 55, 89, 144, 233, ...

is defined by

$$F_0 = 0, F_1 = 1,$$

$$F_{n+2} = F_{n+1} + F_n \quad \text{for } n \geq 0.$$

<http://oeis.org/A000045>

Leonardo Pisano (Fibonacci)
(1170–1250)



The OEIS Foundation is supported by donations from users of the OEIS and by a grant from the Simons Foundation.

0 1 3 6 2 7
: 13
: 20
23
10 22 11 21

THE ON-LINE ENCYCLOPEDIA OF INTEGER SEQUENCES[®]

founded in 1964 by N. J. A. Sloane

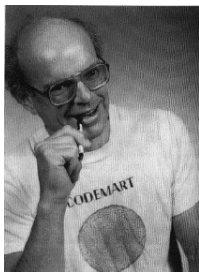

Neil J. A. Sloane's encyclopaedia

<http://oeis.org/>

Fibonacci sequence : <http://oeis.org/A000045>

Fibonacci rabbits

Fibonacci considered the growth of a rabbit population.

A newly born pair of rabbits, a male and a female, are put in a field. Rabbits are able to mate at the age of one month so that at the end of its second month a female can produce another pair of rabbits; rabbits never die and a mating pair always produces

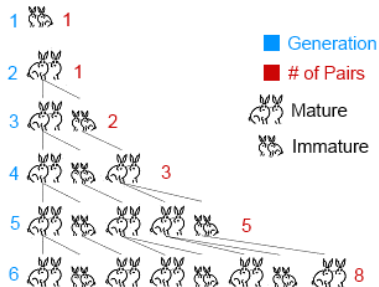

one new pair (one male, one female) every month from the second month on. The puzzle that Fibonacci posed was : how many pairs will there be in one year ?

Answer : $F_{12} = 144$.

Fibonacci's rabbits

Modelization of a population

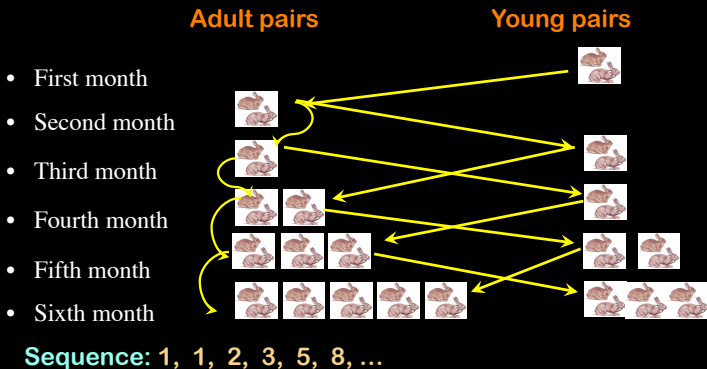

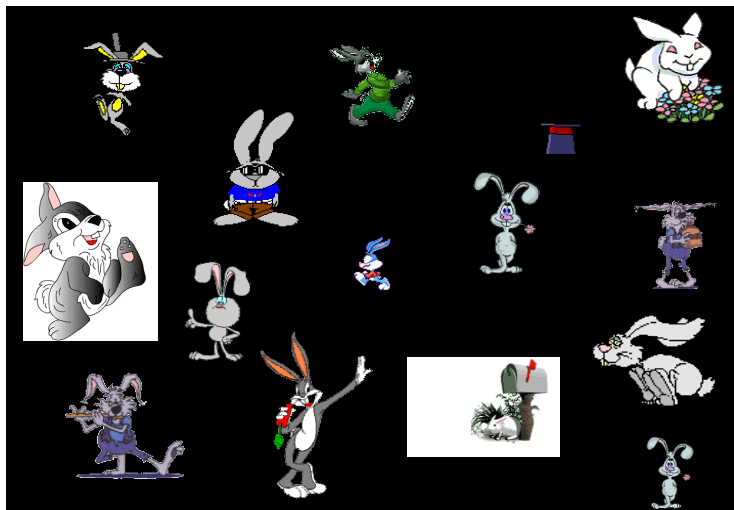

Modelization of a population of mice

Exponential sequence



- First month



- Second month

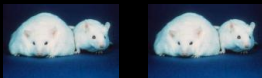

- Third month

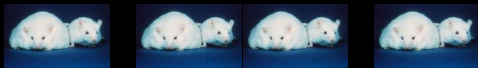

- Fourth month



Number of pairs: 1, 2, 4, 8, ...



Is-it a realistic model ?

The genealogy of the ancestors of a human being is not a mathematical tree :

30 generations would give 2^{30} ancestors, more than a billion people, three to four times more than the total population on earth one thousand years ago.

Even worse for the genealogy of bees :

In every bee hive there is one female queen bee which lays all the eggs. If an egg is not fertilised it eventually hatches into a male bee, called a drone. If an egg is fertilised by a male bee, then the egg produces a female worker bee, which doesn't lay any eggs herself.

Alfred Lotka : arctic trees

In cold countries, each branch of some trees gives rise to another one after the second year of existence only.

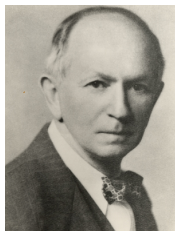

Alfred Lotka
1880 – 1949

Alfred Lotka : American biophysicist, specialist of population dynamics and energetics. Predator–prey model, developed simultaneously but independently of Vito Volterra.

Fibonacci squares

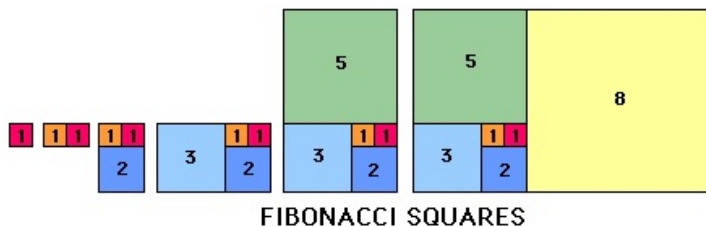

<http://mathforum.org/dr.math/faq/faq.golden.ratio.html>

Geometric construction of the Fibonacci sequence

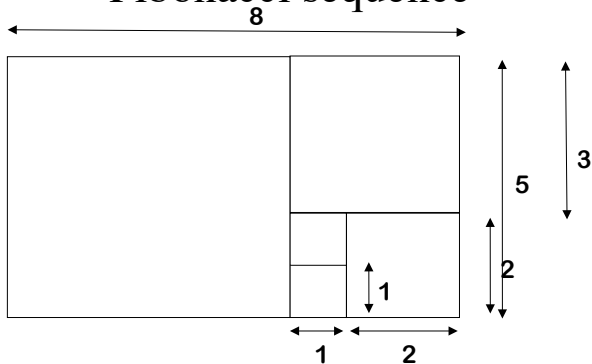

This is a nice rectangle

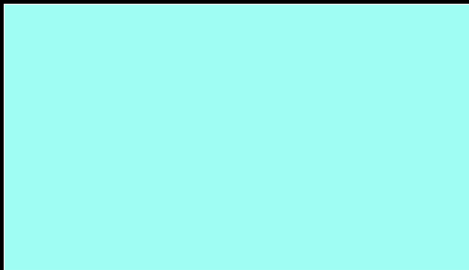

Golden rectangle

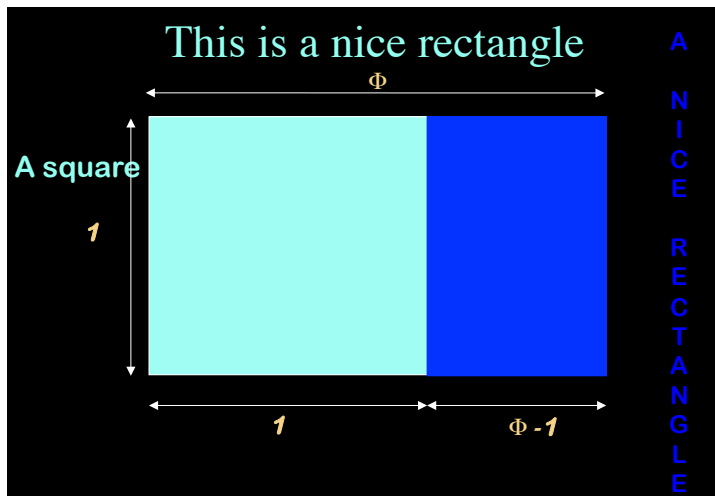

$$\frac{\Phi}{1} = \frac{1}{\Phi - 1}$$

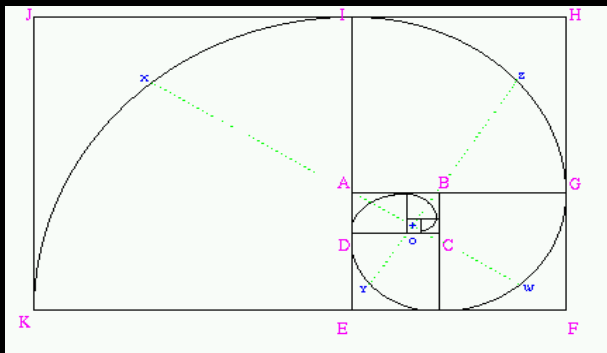

Fibonacci numbers in nature

Ammonite (Nautilus shape)

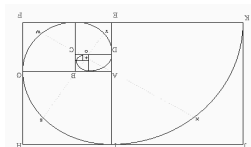
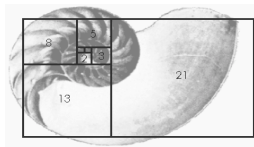
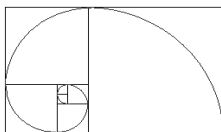

Phyllotaxy



- Study of the position of leaves on a stem and the reason for them
- Number of petals of flowers: daisies, sunflowers, aster, chicory, asteraceae,...
- Spiral pattern to permit optimal exposure to sunlight
- Pine-cone, pineapple, Romanesco cawliflower, cactus

Leaf arrangements

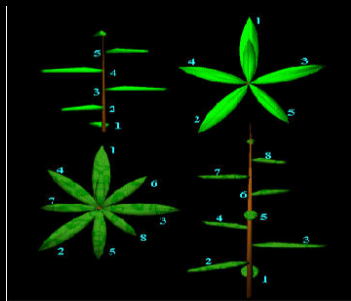

- Université de Nice,
Laboratoire Environnement Marin Littoral,
Equipe d'Accueil "Gestion de la
Biodiversité"



<http://www.unice.fr/LEML/coursJDV/tp/tp3.htm>

Phyllotaxy



Phyllotaxy

- J. Kepler (1611) uses the Fibonacci sequence in his study of the dodecahedron and the icosaedron, and then of the symmetry of order 5 of the flowers.
- Stéphane Douady and Yves Couder
Les spirales végétales
La Recherche 250 (Jan. 1993) vol. **24**.

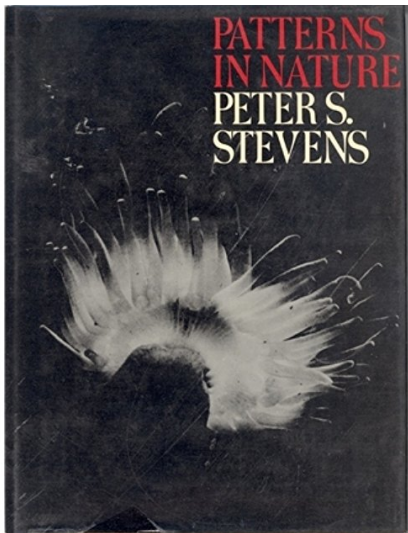

ON GROWTH AND FORM

The Complete Revised Edition



D'Arcy Wentworth Thompson

Reflections of a ray of light

Consider three parallel sheets of glass and a ray of light which crosses the first sheet. Each time it touches one of the sheets, it can cross it or reflect on it.

Denote by p_n the number of different paths with the ray going out of the system after n reflections.

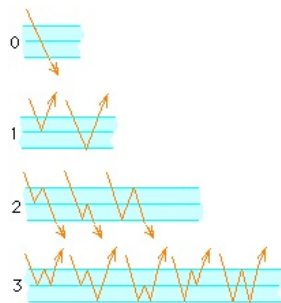

$$p_0 = 1,$$

$$p_1 = 2,$$

$$p_2 = 3,$$

$$p_3 = 5.$$

In general, $p_n = F_{n+2}$.

Levels of energy of an electron of an atom of hydrogen

An atom of hydrogen can have three levels of energy, 0 at the ground level when it does not move, 1 or 2. At each step, it **alternatively** gains and loses some level of energy, either 1 or 2, without going sub 0 nor above 2. Let ℓ_n be the number of different possible scenarios for this electron after n steps.

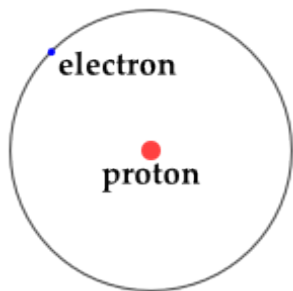

In general, $\ell_n = F_{n+2}$.

We have $\ell_0 = 1$ (initial state level 0)

$\ell_1 = 2$: state 1 or 2, scenarios (ending with gain) 01 or 02.

$\ell_2 = 3$: scenarios (ending with loss) 010, 021 or 020.

$\ell_3 = 5$: scenarios (ending with gain) 0101, 0102, 0212, 0201 or 0202.

Rhythmic patterns

The **Fibonacci** sequence appears in Indian mathematics, in connection with Sanskrit prosody. Several Indian scholars, **Pingala** (200 BC), **Virahanka** (c. 700 AD), **Gopāla** (c. 1135), and the Jain scholar **Hemachandra** (c. 1150). studied rhythmic patterns that are formed by concatenating one beat notes ● and double beat notes ■■.

one-beat note ● : short syllabe (ti in **Morse** Alphabet)

double beat note ■■ : long syllabe (ta ta in **Morse**)

1 beat, 1 pattern : ●

2 beats, 2 patterns : ● ● and ■■

3 beats, 3 patterns : ● ● ● , ● ■■ and ■■ ●

4 beats, 5 patterns :

● ● ● ● , ■■ ● ● , ● ■■ ● , ● ● ■■ , ■■ ■■

n beats, F_{n+1} patterns.

Fibonacci sequence and the Golden ratio

For $n \geq 0$, the Fibonacci number F_n is the nearest integer to

$$\frac{1}{\sqrt{5}}\Phi^n,$$

where Φ is the *Golden Ratio*: <http://oeis.org/A001622>

$$\Phi = \frac{1 + \sqrt{5}}{2} = \lim_{n \rightarrow \infty} \frac{F_{n+1}}{F_n} = 1.6180339887499 \dots$$

which satisfies

$$\Phi = 1 + \frac{1}{\Phi}.$$

Binet's formula

For $n \geq 0$,

$$F_n = \frac{\Phi^n - (-\Phi)^{-n}}{\sqrt{5}}$$
$$= \frac{(1 + \sqrt{5})^n - (1 - \sqrt{5})^n}{2^n \sqrt{5}},$$



Jacques Philippe Marie Binet
1786–1856

$$\Phi = \frac{1 + \sqrt{5}}{2}, \quad -\Phi^{-1} = \frac{1 - \sqrt{5}}{2},$$

$$X^2 - X - 1 = (X - \Phi)(X + \Phi^{-1}).$$

The so-called Binet Formula

Formula of A. De Moivre (1718, 1730), Daniel Bernoulli (1726), L. Euler (1728, 1765), J.P.M. Binet (1843) : for $n \geq 0$,

$$F_n = \frac{1}{\sqrt{5}} \left(\frac{1 + \sqrt{5}}{2} \right)^n - \frac{1}{\sqrt{5}} \left(\frac{1 - \sqrt{5}}{2} \right)^n .$$

Abraham de Moivre
(1667–1754)

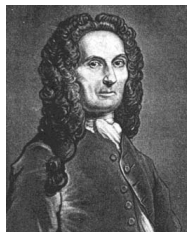

Daniel Bernoulli
(1700–1782)



Leonhard Euler
(1707–1783)



Jacques P.M. Binet
(1786–1856)



Generating series

A single series encodes all the **Fibonacci** sequence :

$$\sum_{n \geq 0} F_n X^n = X + X^2 + 2X^3 + 3X^4 + 5X^5 + \dots + F_n X^n + \dots$$

Fact : this series is the **Taylor** expansion of a rational fraction :

$$\sum_{n \geq 0} F_n X^n = \frac{X}{1 - X - X^2}.$$

Proof : the product

$$(X + X^2 + 2X^3 + 3X^4 + 5X^5 + 8X^6 + \dots)(1 - X - X^2)$$

is a telescoping series

$$\begin{array}{r} X + X^2 + 2X^3 + 3X^4 + 5X^5 + 8X^6 + \dots \\ -X^2 - X^3 - 2X^4 - 3X^5 - 5X^6 - \dots \\ -X^3 - X^4 - 2X^5 - 3X^6 - \dots \\ \hline = X. \end{array}$$

Generating series of the Fibonacci sequence

Remark. The denominator $1 - X - X^2$ in the right hand side of

$$X + X^2 + 2X^3 + 3X^4 + \cdots + F_n X^n + \cdots = \frac{X}{1 - X - X^2}$$

is $X^2 f(X^{-1})$, where $f(X) = X^2 - X - 1$ is the irreducible polynomial of the Golden ratio Φ .

Homogeneous linear differential equation

Consider the homogeneous linear differential equation

$$y'' - y' - y = 0.$$

If $y = e^{\lambda x}$ is a solution, from $y' = \lambda y$ and $y'' = \lambda^2 y$ we deduce

$$\lambda^2 - \lambda - 1 = 0.$$

The two roots of the polynomial $X^2 - X - 1$ are Φ (the Golden ratio) and Φ' with

$$\Phi' = 1 - \Phi = -\frac{1}{\Phi}.$$

A basis of the space of solutions is given by the two functions $e^{\Phi x}$ and $e^{\Phi' x}$. Since (Binet's formula)

$$\sum_{n \geq 0} F_n \frac{x^n}{n!} = \frac{1}{\sqrt{5}} (e^{\Phi x} - e^{\Phi' x}),$$

this exponential generating series of the Fibonacci sequence is a solution of the differential equation.

Fibonacci and powers of matrices

The Fibonacci linear recurrence relation $F_{n+2} = F_{n+1} + F_n$ for $n \geq 0$ can be written

$$\begin{pmatrix} F_{n+1} \\ F_{n+2} \end{pmatrix} = \begin{pmatrix} 0 & 1 \\ 1 & 1 \end{pmatrix} \begin{pmatrix} F_n \\ F_{n+1} \end{pmatrix}.$$

By induction one deduces, for $n \geq 0$,

$$\begin{pmatrix} F_n \\ F_{n+1} \end{pmatrix} = \begin{pmatrix} 0 & 1 \\ 1 & 1 \end{pmatrix}^n \begin{pmatrix} 0 \\ 1 \end{pmatrix}.$$

An equivalent formula is, for $n \geq 1$,

$$\begin{pmatrix} 0 & 1 \\ 1 & 1 \end{pmatrix}^n = \begin{pmatrix} F_{n-1} & F_n \\ F_n & F_{n+1} \end{pmatrix}.$$

Characteristic polynomial

The characteristic polynomial of the matrix

$$A = \begin{pmatrix} 0 & 1 \\ 1 & 1 \end{pmatrix}$$

is

$$\det(XI - A) = \det \begin{pmatrix} X & -1 \\ -1 & X - 1 \end{pmatrix} = X^2 - X - 1,$$

which is the irreducible polynomial of the Golden ratio Φ .

Fibonacci sequence and the Golden ratio (continued)

For $n \geq 1$, $\Phi^n \in \mathbb{Z}[\Phi] = \mathbb{Z} + \mathbb{Z}\Phi$ is a linear combination of 1 and Φ with integer coefficients, namely

$$\Phi^n = F_{n-1} + F_n \Phi.$$

Fibonacci sequence and Hilbert's 10th problem

Yuri Matiyasevich (1970) showed that there is a polynomial P in n , m , and a number of other variables x, y, z, \dots having the property that $n = F_{2m}$ iff there exist integers x, y, z, \dots such that $P(n, m, x, y, z, \dots) = 0$.

This completed the proof of the impossibility of the tenth of Hilbert's problems (*does there exist a general method for solving Diophantine equations?*) thanks to the previous work of Hilary Putnam, Julia Robinson and Martin Davis.

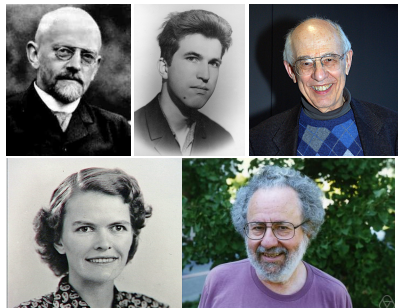

The Fibonacci Quarterly

The **Fibonacci** sequence satisfies a lot of very interesting properties. Four times a year, the **Fibonacci Quarterly** publishes an issue with new properties which have been discovered.

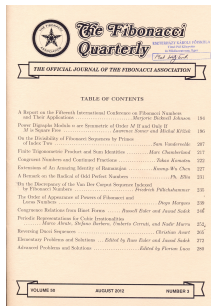

The image shows the cover of the journal 'The Fibonacci Quarterly'. At the top left is a circular logo with a five-pointed star. To its right, the title 'The Fibonacci Quarterly' is written in a stylized font, with 'MEMBERSHIP: \$10.00 PER ANNUM' in smaller text below it. A banner below the title reads 'THE OFFICIAL JOURNAL OF THE FIBONACCI ASSOCIATION'. The main body of the cover is titled 'TABLE OF CONTENTS' and lists various articles with their authors and page numbers. At the bottom, a banner indicates 'VOLUME 58 AUGUST 2022 NUMBER 2'.

| TABLE OF CONTENTS | |
|--|-----|
| A Report on the Fibonaci International Conference on Fibonaci Numbers and Their Applications Myrnes, Richard Johnson | 154 |
| Prime Fibonacci Numbers in an System of Order M and Order H in M in Number Base Gannon, Scott and Hilda Kröner | 186 |
| On the Distributivity of Fibonaci Sequences by Prime Sen, Vandana | 207 |
| Fibonacci Triangulation, Product and Sum Identities Hare, Chandraleela | 217 |
| Congruence Numbers and Congruent Primitives Baker, Kenneth | 222 |
| Extension of An Amazing Identity of Binet's Kooze, Wu Chen | 227 |
| A Remark on the Radical of Odd Perfect Numbers Ph, Alha | 231 |
| On the Distributivity of the Van Der Corput Sequence Indexed by Fibonaci Numbers Prasad, Pichaiannan | 235 |
| The Order of Appearance of Powers of Fibonaci and Lucas Numbers Dey, Harpreet | 239 |
| Congruence Relations from Base Two Anand, Diler and Anil, Sankh | 246 |
| Periodic Representations for Cube Intendings Gaur, Aksh, Shikha, Arshvi, Chakri, Corral, and Nishi, Haris | 252 |
| Revisiting Lucas Sequences Christian, Anant | 265 |
| Elementary Problems and Solutions Edited by Ross, Eileen and Jerald, Sankh | 272 |
| Advanced Problems and Solutions Edited by Phares, Leon | 285 |

VOLUME 58 AUGUST 2022 NUMBER 2

Why are there so many occurrences of Fibonacci numbers and Golden ratio in the nature?

According to Leonid Levin, objects with a small algorithmic Kolmogorov complexity (generated by a short program) occur more often than others.



Another example is given by Sierpinski triangles.

Reference : J-P. Delahaye.

<http://cristal.univ-lille.fr/~jdelahay/pls/>

Lucas sequence

<http://oeis.org/000032>

The Lucas sequence $(L_n)_{n \geq 0}$ satisfies the same recurrence relation as the Fibonacci sequence, namely

$$L_{n+2} = L_{n+1} + L_n \quad \text{for } n \geq 0,$$

only the initial values are different :

$$L_0 = 2, \quad L_1 = 1.$$

The sequence of Lucas numbers starts with

2, 1, 3, 4, 7, 11, 18, 29, 47, 76, 123, 199, 322, ...

A closed form involving the Golden ratio Φ is

$$L_n = \Phi^n + (-\Phi)^{-n},$$

from which it follows that for $n \geq 2$, L_n is the nearest integer to Φ^n .

François Édouard Anatole Lucas

Edouard Lucas is best known for his results in number theory. He studied the Fibonacci sequence and devised the test for Mersenne primes still used today.



Édouard Lucas
1842 - 1891

<http://www-history.mcs.st-andrews.ac.uk/history/Mathematicians/Lucas.html>

Generating series of the Lucas sequence

The generating series of the Lucas sequence

$$\sum_{n \geq 0} L_n X^n = 2 + X + 3X^2 + 4X^3 + \cdots + L_n X^n + \cdots$$

is nothing else than

$$\frac{2 - X}{1 - X - X^2}.$$

Homogeneous linear differential equation

We have seen that

$$\sum_{n \geq 0} F_n \frac{x^n}{n!} = \frac{1}{\sqrt{5}} (e^{\Phi x} - e^{\Phi' x})$$

is a solution of the homogeneous linear differential equation

$$y'' - y' - y = 0.$$

Since

$$\sum_{n \geq 0} L_n \frac{x^n}{n!} = e^{\Phi x} + e^{\Phi' x},$$

we deduce that a basis of the space of solutions is given by the two generating series

$$\sum_{n \geq 0} F_n \frac{x^n}{n!} \quad \text{and} \quad \sum_{n \geq 0} L_n \frac{x^n}{n!}.$$

The Lucas sequence and power of matrices

From the linear recurrence relation $L_{n+2} = L_{n+1} + L_n$ one deduces, (as we did for the Fibonacci sequence), for $n \geq 0$,

$$\begin{pmatrix} L_{n+1} \\ L_{n+2} \end{pmatrix} = \begin{pmatrix} 0 & 1 \\ 1 & 1 \end{pmatrix} \begin{pmatrix} L_n \\ L_{n+1} \end{pmatrix},$$

hence

$$\begin{pmatrix} L_n \\ L_{n+1} \end{pmatrix} = \begin{pmatrix} 0 & 1 \\ 1 & 1 \end{pmatrix}^n \begin{pmatrix} 2 \\ 1 \end{pmatrix}.$$

Take three of the four sequences

$$(F_n)_{n \geq 0}, (L_n)_{n \geq 0}, (\Phi^n)_{n \geq 0}, ((-\Phi)^{-n})_{n \geq 0}.$$

Any one of them can be written as a linear combination of the two others (vector space of dimension 2).

Another binary linear recurrence sequence

A balancing number is an integer $B \geq 0$ such that there exists C with

$$1 + 2 + 3 + \cdots + (B - 1) = (B + 1) + (B + 2) + \cdots + C.$$

Same as $B^2 = C(C + 1)/2$: a balancing number is an integer B such that B^2 is a triangular number (and a square!).

Sequence of balancing numbers : <https://oeis.org/A001109>

0, 1, 6, 35, 204, 1189, 6930, 40391, 235416, 1372105, 7997214 ...

This is a linear recurrence sequence

$$B_{n+1} = 6B_n - B_{n-1}$$

with the initial conditions $B_0 = 0$, $B_1 = 1$.

Sequence $(B_n)_{n \geq 0}$ of balancing numbers :

$$2B_n^2 = C_n(C_n + 1)$$

The corresponding sequence $(C_n)_{n \geq 0}$ is

<https://oeis.org/A001108>

0, 1, 8, 49, 288, 1681, 9800, 57121, 332928, 1940449, ...

The solutions of $x^2 - 2y^2 = 1$ are given by

$$x_n = 2B_n, \quad y_n = 2C_n + 1.$$

Both sequences $(x_n)_{n \geq 0}$ and $(y_n)_{n \geq 0}$ satisfy

$$u_{n+1} = 6u_n - u_{n-1}.$$

with $x_0 = 0$, $x_1 = 2$, $y_0 = 1$, $y_1 = 3$.

Hence

$$C_{n+1} = 6C_n - C_{n-1} + 2.$$

An interesting street number

The puzzle itself was about a street in the town of Louvain in Belgium, where houses are numbered consecutively. One of the house numbers had the peculiar property that the total of the numbers lower than it was exactly equal to the total of the numbers above it. Furthermore, the mysterious house number was greater than 50 but less than 500.



Prasanta Chandra Mahalanobis
1893 – 1972



Srinivasa Ramanujan
1887 – 1920

The answer to the puzzle is : house 204 in a street with 288 houses.

The sequence of balancing numbers

Characteristic polynomial :

$$f(X) = X^2 - 6X + 1 = (X - 3 - 2\sqrt{2})(X - 3 + 2\sqrt{2}).$$

Closed formula :

$$B_n = \frac{1}{4\sqrt{2}} \left((3 + 2\sqrt{2})^n - (3 - 2\sqrt{2})^n \right).$$

Generating series :

$$\varphi(X) = \sum_{n \geq 0} B_n X^n = X + 6X^2 + 35X^3 + \dots = \frac{X}{1 - 6X + X^2}.$$

Exercise :

$$X^2 \varphi' = (1 - X^2) \varphi^2.$$

Takao Komatsu & Prasanta Kumar Ray. *Higher-order identities for balancing numbers*.

arXiv:1608.05925 [math.NT]

Exponential generating series of the sequence of balancing numbers

$$\begin{aligned}y(x) &= \sum_{n \geq 0} B_n \frac{x^n}{n!} \\&= x + 3x^2 + \frac{35}{6}x^3 + \dots \\&= \frac{1}{4\sqrt{2}} \left(e^{(3+2\sqrt{2})x} - e^{(3-2\sqrt{2})x} \right).\end{aligned}$$

This is the solution of the homogeneous linear differential equation of order 2

$$y'' = 6y' - y$$

with the initial conditions $y(0) = 0$, $y'(0) = 1$.

Balancing numbers and the matrix $A = \begin{pmatrix} 0 & 1 \\ -1 & 6 \end{pmatrix}$

$$\begin{pmatrix} B_{n+1} \\ B_{n+2} \end{pmatrix} = \begin{pmatrix} 0 & 1 \\ -1 & 6 \end{pmatrix} \begin{pmatrix} B_n \\ B_{n+1} \end{pmatrix} \quad (n \geq 0).$$

Powers of A :

$$\begin{pmatrix} 0 & 1 \\ -1 & 6 \end{pmatrix}^n = \begin{pmatrix} -B_n & B_{n+1} \\ -B_{n+1} & B_{n+2} \end{pmatrix} \quad (n \geq 0).$$

Characteristic polynomial :

$$\det(XI - A) = \det \begin{pmatrix} X & -1 \\ 1 & X - 6 \end{pmatrix} = X^2 - 6X + 1.$$

Perrin sequence

<http://oeis.org/A001608>

The Perrin sequence (also called *skiponacci sequence*) is the linear recurrence sequence $(P_n)_{n \geq 0}$ defined by

$$P_{n+3} = P_{n+1} + P_n \quad \text{for } n \geq 0,$$

with the initial conditions

$$P_0 = 3, P_1 = 0, P_2 = 2.$$

It starts with

3, 0, 2, 3, 2, 5, 5, 7, 10, 12, 17, 22, 29, 39, 51, 68, ...

François Olivier Raoul Perrin (1841-1910) :

https://en.wikipedia.org/wiki/Perrin_number

Plastic (or silver) constant

<https://oeis.org/A060006>

The ratio of successive terms in the **Perrin** sequence approaches the plastic number

$$\rho = 1.324\,717\,957\,244\,746\dots$$

which is the minimal **Pisot–Vijayaraghavan** number, real root of

$$x^3 - x - 1.$$

This constant is equal to

$$\rho = \frac{\sqrt[3]{108 + 12\sqrt{69}} + \sqrt[3]{108 - 12\sqrt{69}}}{6}.$$

Perrin sequence and the plastic constant

Decompose the polynomial $X^3 - X - 1$ into irreducible factors over \mathbb{C}

$$X^3 - X - 1 = (X - \varrho)(X - \rho)(X - \bar{\rho})$$

and over \mathbb{R}

$$X^3 - X - 1 = (X - \varrho)(X^2 + \varrho X + \varrho^{-1}).$$

Hence ρ and $\bar{\rho}$ are the roots of $X^2 + \varrho X + \varrho^{-1}$. Then, for $n \geq 0$,

$$P_n = \varrho^n + \rho^n + \bar{\rho}^n.$$

It follows that, for $n \geq 0$, P_n is the nearest integer to ϱ^n .

Generating series of the Perrin sequence

The generating series of the Perrin sequence

$$\sum_{n \geq 0} P_n X^n = 3 + 2X^2 + 3X^3 + 2X^4 + \cdots + P_n X^n + \cdots$$

is nothing else than

$$\frac{3 - X^2}{1 - X^2 - X^3}.$$

The denominator $1 - X^2 - X^3$ is $X^3 f(X^{-1})$ where $f(X) = X^3 - X - 1$ is the irreducible polynomial of ϱ .

Exponential generating series of the Perrin sequence

The power series

$$y(x) = \sum_{n \geq 0} P_n \frac{x^n}{n!}$$

is the solution of the differential equation

$$y''' - y' - y = 0$$

with the initial conditions $y(0) = 3$, $y'(0) = 0$, $y''(0) = 2$.

Perrin sequence and power of matrices

From

$$P_{n+3} = P_{n+1} + P_n$$

we deduce

$$\begin{pmatrix} P_{n+1} \\ P_{n+2} \\ P_{n+3} \end{pmatrix} = \begin{pmatrix} 0 & 1 & 0 \\ 0 & 0 & 1 \\ 1 & 1 & 0 \end{pmatrix} \begin{pmatrix} P_n \\ P_{n+1} \\ P_{n+2} \end{pmatrix}.$$

Hence

$$\begin{pmatrix} P_n \\ P_{n+1} \\ P_{n+2} \end{pmatrix} = \begin{pmatrix} 0 & 1 & 0 \\ 0 & 0 & 1 \\ 1 & 1 & 0 \end{pmatrix}^n \begin{pmatrix} 3 \\ 0 \\ 2 \end{pmatrix}.$$

Characteristic polynomial

The characteristic polynomial of the matrix

$$A = \begin{pmatrix} 0 & 1 & 0 \\ 0 & 0 & 1 \\ 1 & 1 & 0 \end{pmatrix}$$

is

$$\det(XI - A) = \det \begin{pmatrix} X & -1 & 0 \\ 0 & X & -1 \\ -1 & -1 & X \end{pmatrix} = X^3 - X - 1,$$

which is the irreducible polynomial of the plastic constant ρ .

Perrin's remark

1484. [I9c] La curieuse proposition d'origine chinoise qui fait l'objet de la question 1401 fournirait, si elle était exacte, un criterium plus pratique que le théorème de Wilson pour vérifier si un nombre donné m est premier ou non ; il suffirait de calculer les résidus par rapport à m des termes successifs de la suite récurrente

$$u_n = 3u_{n-1} - 2u_{n-2}$$

avec les valeurs initiales $u_0 = -1$, $u_1 = 0$.

J'ai rencontré une autre suite récurrente qui paraît jouir de la même propriété ; c'est celle dont le terme général est

$$v_n = v_{n-2} + v_{n-3}$$

— 77 —

avec les valeurs initiales $v_0 = 3$, $v_1 = 0$, $v_2 = 2$. Il est facile de démontrer que v_n est divisible par n , si n est premier ; j'ai vérifié qu'il ne l'est pas dans le cas contraire, jusqu'à des valeurs assez élevées de n ; mais il serait intéressant de savoir ce qu'il en est réellement, d'autant plus que la suite v_n fournit des nombres bien moins rapidement croissants que la suite u_n (pour $n = 17$, par exemple, on trouve $u_n = 131070$, $v_n = 119$), et se prête à des simplifications de calcul lorsque n est un grand nombre.

La même méthode de démonstration, applicable à l'une des suites, le sera sans doute à l'autre, si la propriété énoncée est exacte pour toutes les deux : il ne s'agit que de la découvrir.

R. PERRIN.

R. Perrin *L'intermédiaire des mathématiciens*, Query 1484, v.6, 76–77 (1899).

The website www.Perrin088.org maintained by Richard Turk is devoted to Perrin numbers. See [OEISA113788](https://oeis.org/A113788).

Perrin pseudoprimes

<https://oeis.org/A013998>

If p is prime, then p divides P_p .

The smallest composite n such that n divides P_n is
 $521^2 = 271441$.

The number P_{271441} has 33 150 decimal digits (the number c which satisfies $10^c = \varrho^{271441}$ is $c = 271441(\log \varrho)/(\log 10)$).

Also for the composite number $n = 904631 = 7 \times 13 \times 9941$, the number n divides P_n .

Jon Grantham has proved in 2010 that there are infinitely many Perrin pseudoprimes.

Padovan sequence

<https://oeis.org/A000931>

The Padovan sequence $(p_n)_{n \geq 0}$ satisfies the same recurrence

$$p_{n+3} = p_{n+1} + p_n$$

as the Perrin sequence but has different initial values :

$$p_0 = 1, \quad p_1 = p_2 = 0.$$

It starts with

1, 0, 0, 1, 0, 1, 1, 1, 2, 2, 3, 4, 5, 7, 9, 12, 16, ...

Richard Padovan

<http://mathworld.wolfram.com/LinearRecurrenceEquation.html>

Generating series and power of matrices

$$1 + X^3 + X^5 + \cdots + p_n X^n + \cdots = \frac{1 - X^2}{1 - X^2 - X^3}.$$

For $n \geq 0$,

$$\begin{pmatrix} p_n \\ p_{n+1} \\ p_{n+2} \end{pmatrix} = \begin{pmatrix} 0 & 1 & 0 \\ 0 & 0 & 1 \\ 1 & 1 & 0 \end{pmatrix}^n \begin{pmatrix} 1 \\ 0 \\ 0 \end{pmatrix}.$$

Padovan triangles

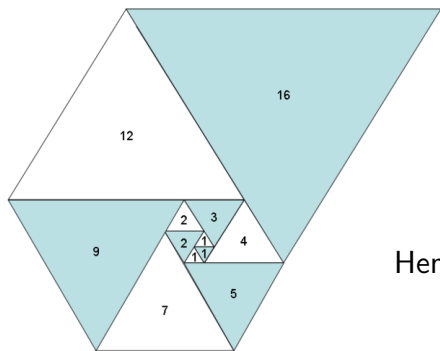

$$p_n = p_{n-2} + p_{n-3}$$

$$p_{n-1} = p_{n-3} + p_{n-4}$$

$$p_{n-2} = p_{n-4} + p_{n-5}$$

Hence

$$p_n - p_{n-1} = p_{n-5}$$

$$p_n = p_{n-1} + p_{n-5}$$

Padovan triangles

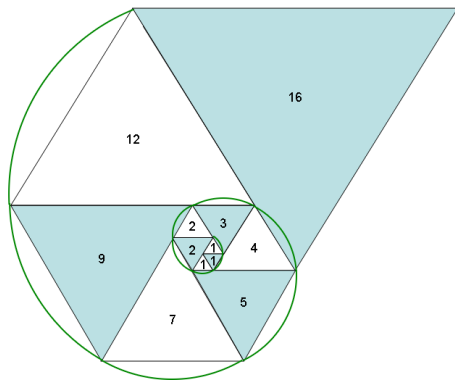

Fibonacci squares vs Padovan triangles

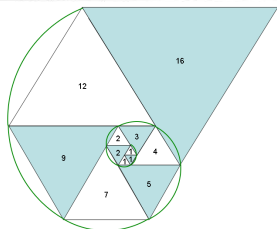
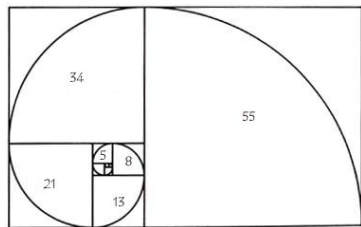

Both are C^1 curve, not C^2

Padovan, Euler, Zagier, Goncharov and Brown

For $n \geq 0$, the number of compositions $\underline{s} = (s_1, \dots, s_k)$ with $s_i \in \{2, 3\}$ and $s_1 + \dots + s_k = n$ is p_{n+3} . This is (an upper bound for) the dimension of the space spanned by the multiple zeta values of weight n of Euler and Zagier.



Leonhard Euler



Don Zagier



Alexander Goncharov



Francis Brown

Narayana sequence

<https://oeis.org/A000930>

Narayana sequence is defined by the recurrence relation

$$C_{n+3} = C_{n+2} + C_n$$

with the initial values $C_0 = 2$, $C_1 = 3$, $C_2 = 4$.

It starts with

2, 3, 4, 6, 9, 13, 19, 28, 41, 60, 88, 129, 189, 277, ...

Real root of $x^3 - x^2 - 1$

$$\frac{\sqrt[3]{\frac{29 + 3\sqrt{93}}{2}} + \sqrt[3]{\frac{29 - 3\sqrt{93}}{2}} + 1}{3} = 1.465571231876768\dots$$

Generating series and power of matrices

$$2 + 3X + 4X^2 + 6X^3 + \dots + C_n X^n + \dots = \frac{2 + X + X^2}{1 - X - X^3}.$$

Differential equation : $y''' - y'' - y = 0$;

initial conditions : $y(0) = 2, y'(0) = 3, y''(0) = 4$.

For $n \geq 0$,

$$\begin{pmatrix} C_n \\ C_{n+1} \\ C_{n+2} \end{pmatrix} = \begin{pmatrix} 0 & 1 & 0 \\ 0 & 0 & 1 \\ 1 & 0 & 1 \end{pmatrix}^n \begin{pmatrix} 2 \\ 3 \\ 4 \end{pmatrix}.$$

Narayana's cows

Narayana was an Indian mathematician in the 14th century who proposed the following problem :

A cow produces one calf every year. Beginning in its fourth year each calf produces one calf at the beginning of each year. How many calves are there altogether after, for example, 17 years ?

Music :

<http://www.pogus.com/21033.html>

In working this out, Tom Johnson found a way to translate this into a composition called *Narayana's Cows*.

Music : Tom Johnson

Saxophones : Daniel Kientzy

Tom Johnson
Les Vaches de Narayana
Narayana's Cows
Narayanans Kühe
Las vacas de Narayana

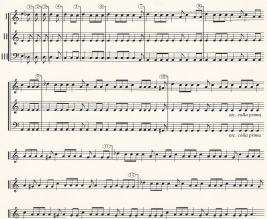

© 1983 by Tom Johnson

The image shows a page of musical notation for the piece 'Narayana's Cows' by Tom Johnson. The score is written for saxophones and consists of six systems of music. Each system includes a treble clef staff with a key signature of one flat and a 4/4 time signature. The notation includes various rhythmic patterns, including eighth and sixteenth notes, and rests. There are also some performance markings like 'mf' and 'p'.



Year 1

1



2



3



4



=



+



Year 2

3

4

5



Narayana's cows

<http://www.math.jussieu.fr/~michel.waldschmidt/>

| Year | 1 | 2 | 3 | 4 | 5 | 6 | 7 | 8 | 9 | 10 | 11 | 12 | 13 | 14 | 15 | 16 | 17 |
|--------------------|----------|----------|----------|----------|----------|-----------|-----------|-----------|-----------|-----------|-----------|------------|------------|------------|------------|------------|------------|
| Original Cow | 1 | 1 | 1 | 1 | 1 | 1 | 1 | 1 | 1 | 1 | 1 | 1 | 1 | 1 | 1 | 1 | 1 |
| Second generation | 1 | 2 | 3 | 4 | 5 | 6 | 7 | 8 | 9 | 10 | 11 | 12 | 13 | 14 | 15 | 16 | 17 |
| Third generation | 0 | 0 | 0 | 1 | 3 | 6 | 10 | 15 | 21 | 28 | 36 | 45 | 55 | 66 | 78 | 91 | 105 |
| Fourth generation | 0 | 0 | 0 | 0 | 0 | 0 | 1 | 4 | 10 | 20 | 35 | 56 | 84 | 120 | 165 | 220 | 286 |
| Fifth generation | 0 | 0 | 0 | 0 | 0 | 0 | 0 | 0 | 0 | 1 | 5 | 15 | 35 | 70 | 126 | 210 | 330 |
| Sixth generation | 0 | 0 | 0 | 0 | 0 | 0 | 0 | 0 | 0 | 0 | 0 | 0 | 1 | 6 | 21 | 56 | 126 |
| Seventh generation | 0 | 0 | 0 | 0 | 0 | 0 | 0 | 0 | 0 | 0 | 0 | 0 | 0 | 0 | 0 | 1 | 7 |
| Total | 2 | 3 | 4 | 6 | 9 | 13 | 19 | 28 | 41 | 60 | 88 | 129 | 189 | 277 | 406 | 595 | 872 |

17th year: 872 cows



Jean-Paul Allouche and Tom Johnson



<http://www.math.jussieu.fr/~jean-paul.allouche/bibliorecente.html>

<http://www.math.jussieu.fr/~allouche/johnson1.pdf>

Cows, music and morphisms

Jean-Paul Allouche and Tom Johnson

- Narayana's Cows and Delayed Morphisms

In 3èmes Journées d'Informatique Musicale (JIM '96), Ile de Tatihou, Les Cahiers du GREYC (1996 no. 4), pages 2-7, May 1996.

<http://kalvos.org/johness1.html>

- Finite automata and morphisms in assisted musical composition,

Journal of New Music Research, no. 24 (1995), 97 – 108.

<http://www.tandfonline.com/doi/abs/10.1080/09298219508570676>

http://web.archive.org/web/19990128092059/www.swets.nl/jnmr/vol24_2.html

Music and the Fibonacci sequence

- Dufay, XV^{ème} siècle
- Roland de Lassus
- Debussy, Bartok, Ravel, Webern
- Stockhausen
- Xenakis
- **Tom Johnson** *Automatic Music for six percussionists*

Some recent work



Christian Ballot

*On a family of recurrences
that includes the Fibonacci
and the Narayana recurrences.*
arXiv:1704.04476 [math.NT]

We survey and prove properties a family of recurrences bears in relation to integer representations, compositions, the Pascal triangle, sums of digits, Nim games and Beatty sequences.

Linear recurrence sequences : examples

$q \geq 1$; initial conditions $u_0 = u_1 = \dots = u_{q-2} = 0, u_{q-1} = 1$.

$$X^q - X^{q-1} - 1 :$$

$q = 1, X - 2$, exponential $u_n = 2^n$

$q = 2, X^2 - X - 1$, Fibonacci $u_n = F_n$

$q = 3, X^3 - X^2 - 1$, Narayana $u_n = C_n$

$$X^q - X^{q-1} - X^{q-2} - \dots - X - 1 :$$

$q = 1, X - 1$, constant sequence $u_n = 1$

$q = 2, X^2 - X - 1$, Fibonacci $u_n = F_n$

$q = 3, X^3 - X^2 - X - 1$, Tribonacci

$$X^q - X - 1 :$$



भारतीय विज्ञान शिक्षा एवं अनुसंधान संस्थान बरहमपुर
Indian Institute of Science Education and Research Berhampur

Mathematics Online Seminar Series 2020

Linear recurrence sequences: part I

Michel Waldschmidt

Institut de Mathématiques de Jussieu — Sorbonne Université

<http://www.math.jussieu.fr/~michel.waldschmidt/>