

Dynamics and Geometry of Moduli Spaces

Lecture 1. From billiards to flat surfaces

Anton Zorich
University Paris Cité

March 7, 2023

*“You, my forest and water! One swerves, while the other shall spout
Through your body like draught; one declares, while the first has a doubt.”*

J. Brodsky

*Ты, мой лес и вода, кто обведет, а кто, как сквозняк,
проникает в тебя, кто глаголет, а кто обняк...*

И. Бродский

Periodic billiards

- Random walk
- Lorentz gas
- Windtree model
- From billiards to surface foliations

Why billiards?

From billiards to surface foliations

Very flat surfaces

Periodic billiards

Central limit theorem

Let X_1, \dots, X_n be a sequence of independent and identically distributed random variables (heads or tails, measurements in uncorrelated experiments, etc). Assume that the variance σ^2 is finite and that the expected value is 0. Let $S_n := X_1 + \dots + X_n$. Clearly, with probability one one has

$$\frac{X_1 + \dots + X_n}{n} = \frac{S_n}{n} \rightarrow 0 \quad \text{as } n \rightarrow +\infty.$$

The Central Limit Theorem describes the expected deviation of the sum S_n from 0. In a sense, it is one of the fundamental laws of Nature:

Central Limit Theorem. *The distribution of the the sum S_n normalized by the factor $\frac{1}{\sqrt{n}}$ tends to the normal distribution with mean 0 and variance σ^2 .*

Random walk and brownian motion in the plane

Random walk. For every step you flip two coins; depending of the combination you go one step forward, one step backward, one step right, or one step left.



Corollary of the Central Limit Theorem. *The root of the mean square of the translation distance after n steps of a random walk with zero mean is*

$$\sqrt{E|S_n^2|} = \sigma\sqrt{n} = \sigma \cdot n^{\frac{1}{2}}.$$

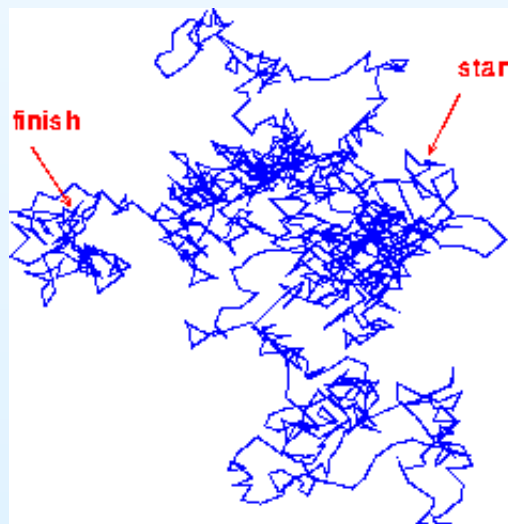

Lorentz gas and Sinai billiard. Finite horizon.

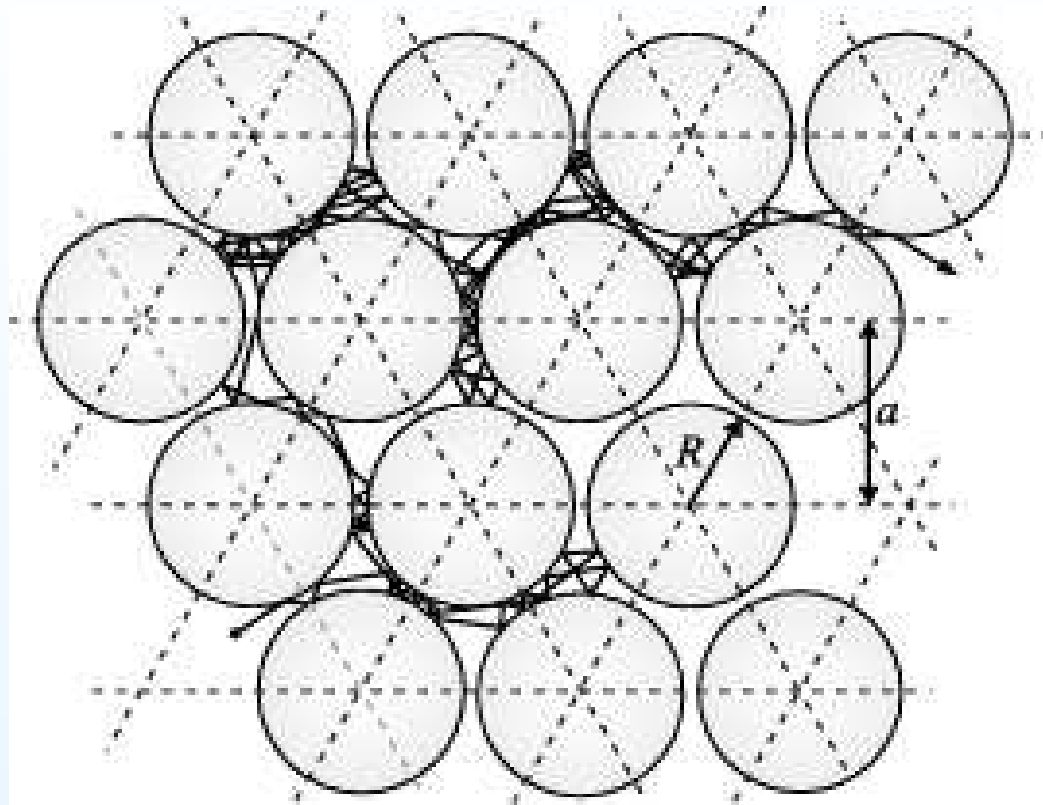

Theorem (Bunimovich, Chernov, Sinai, 1991). *For periodic configuration of convex scatterers on the plane the particle after scaling by \sqrt{t} satisfies the Central Limit Theorem if the horizon is finite (that is, if any ray intersects a scatterer).*

Lorentz gas and Sinai billiard. Infinite horizon.

Theorem (Szász, Varjú, 2007; some ideas — Bleher, 1992).

In infinite horizon case, for example, for round scatterers placed at the lattice points, the Central Limit Theorem still holds but the scaling should be by $\sqrt{t \ln t}$.

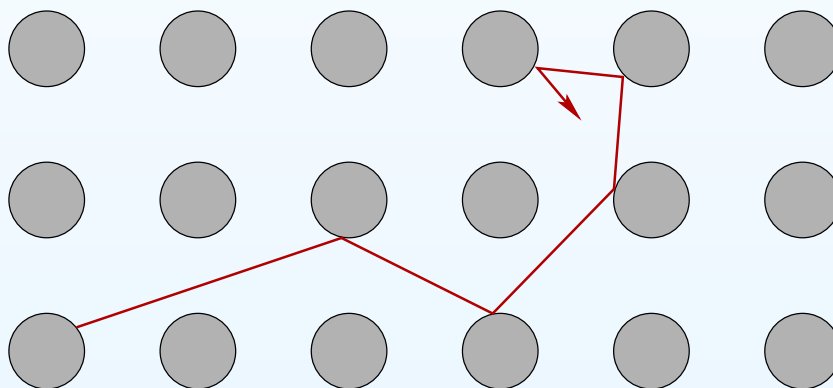

Chernov, Dolgopyat (2009): further interesting results in this direction.

In all cases the *diffusion rate* is again $\frac{1}{2}$ as for the random walk.

Diffusion in a periodic billiard (Ehrenfest “Windtree model”)

Consider a billiard on the plane with \mathbb{Z}^2 -periodic rectangular obstacles.

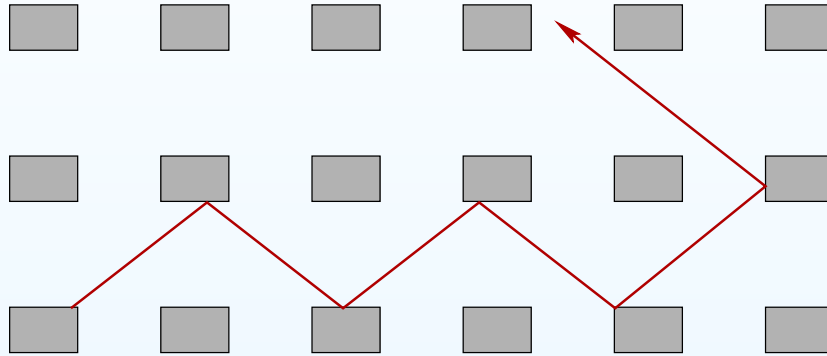

Theorem (V. Delecroix, P. Hubert, S. Lelièvre, 2014). *For all parameters of the obstacle, for almost all initial directions, and for any starting point, the billiard trajectory spreads in the plane with the speed $\sim t^{2/3}$. That is,*

$$\lim_{t \rightarrow +\infty} \log(\text{diameter of trajectory of length } t) / \log t = \frac{2}{3} \neq \frac{1}{2}.$$

The diffusion rate $\frac{2}{3}$ is given by the Lyapunov exponent of certain renormalizing dynamical system associated to the initial one.

Remark. Changing the height and the width of the obstacle we get quite different billiards, but this does not change the diffusion rate!

Diffusion in a periodic billiard (Ehrenfest “Windtree model”)

Consider a billiard on the plane with \mathbb{Z}^2 -periodic rectangular obstacles.

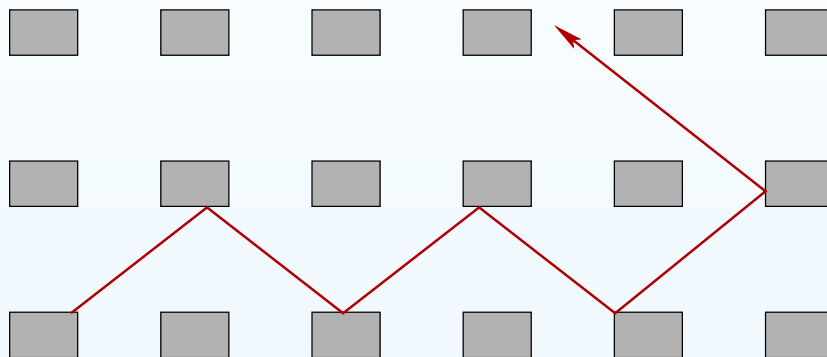

Theorem (V. Delecroix, P. Hubert, S. Lelièvre, 2014). *For all parameters of the obstacle, for almost all initial directions, and for any starting point, the billiard trajectory spreads in the plane with the speed $\sim t^{2/3}$. That is,*

$$\lim_{t \rightarrow +\infty} \log(\text{diameter of trajectory of length } t) / \log t = \frac{2}{3} \neq \frac{1}{2}.$$

The diffusion rate $\frac{2}{3}$ is given by the Lyapunov exponent of certain renormalizing dynamical system associated to the initial one.

Remark. Changing the height and the width of the obstacle we get quite different billiards, but this does not change the diffusion rate!

Diffusion in a periodic billiard (Ehrenfest “Windtree model”)

Consider a billiard on the plane with \mathbb{Z}^2 -periodic rectangular obstacles.

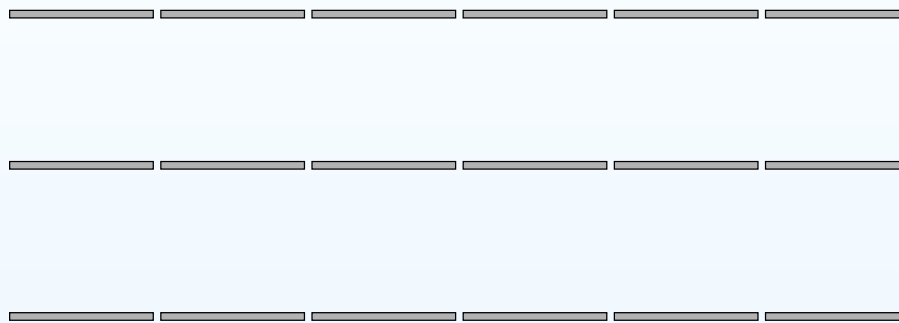

Theorem (V. Delecroix, P. Hubert, S. Lelièvre, 2014). *For all parameters of the obstacle, for almost all initial directions, and for any starting point, the billiard trajectory spreads in the plane with the speed $\sim t^{2/3}$. That is,*

$$\lim_{t \rightarrow +\infty} \log(\text{diameter of trajectory of length } t) / \log t = \frac{2}{3} \neq \frac{1}{2}.$$

The diffusion rate $\frac{2}{3}$ is given by the Lyapunov exponent of certain renormalizing dynamical system associated to the initial one.

Remark. Changing the height and the width of the obstacle we get quite different billiards, but this does not change the diffusion rate!

Diffusion in a periodic billiard (Ehrenfest “Windtree model”)

Consider a billiard on the plane with \mathbb{Z}^2 -periodic rectangular obstacles.

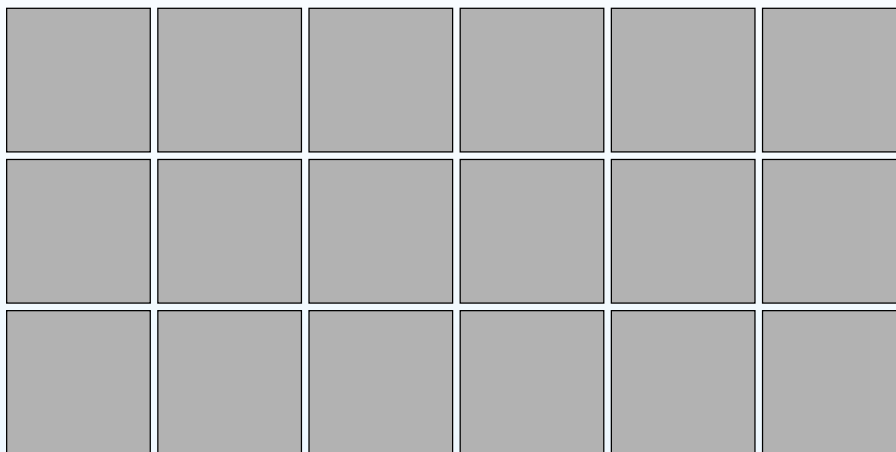

Theorem (V. Delecroix, P. Hubert, S. Lelièvre, 2014). *For all parameters of the obstacle, for almost all initial directions, and for any starting point, the billiard trajectory spreads in the plane with the speed $\sim t^{2/3}$. That is,*

$$\lim_{t \rightarrow +\infty} \log(\text{diameter of trajectory of length } t) / \log t = \frac{2}{3} \neq \frac{1}{2}.$$

The diffusion rate $\frac{2}{3}$ is given by the Lyapunov exponent of certain renormalizing dynamical system associated to the initial one.

Remark. Changing the height and the width of the obstacle we get quite different billiards, but this does not change the diffusion rate!

From billiards to surface foliations

Consider a rectangular billiard. Instead of reflecting the trajectory we can reflect the billiard table. The trajectory unfolds to a straight line. Folding back the copies of the billiard table we project this line to the original trajectory. At any moment the ball moves in one of four directions defining four types of copies of the billiard table. Copies of the same type are related by a parallel translation.

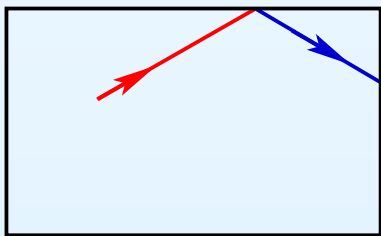

From billiards to surface foliations

Consider a rectangular billiard. Instead of reflecting the trajectory we can reflect the billiard table. The trajectory unfolds to a straight line. Folding back the copies of the billiard table we project this line to the original trajectory. At any moment the ball moves in one of four directions defining four types of copies of the billiard table. Copies of the same type are related by a parallel translation.

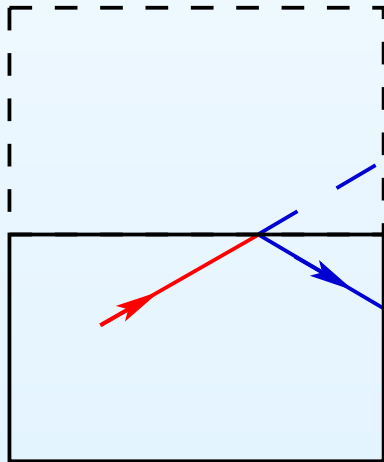

From billiards to surface foliations

Consider a rectangular billiard. Instead of reflecting the trajectory we can reflect the billiard table. **The trajectory unfolds to a straight line.** Folding back the copies of the billiard table we project this line to the original trajectory. At any moment the ball moves in one of four directions defining four types of copies of the billiard table. Copies of the same type are related by a parallel translation.

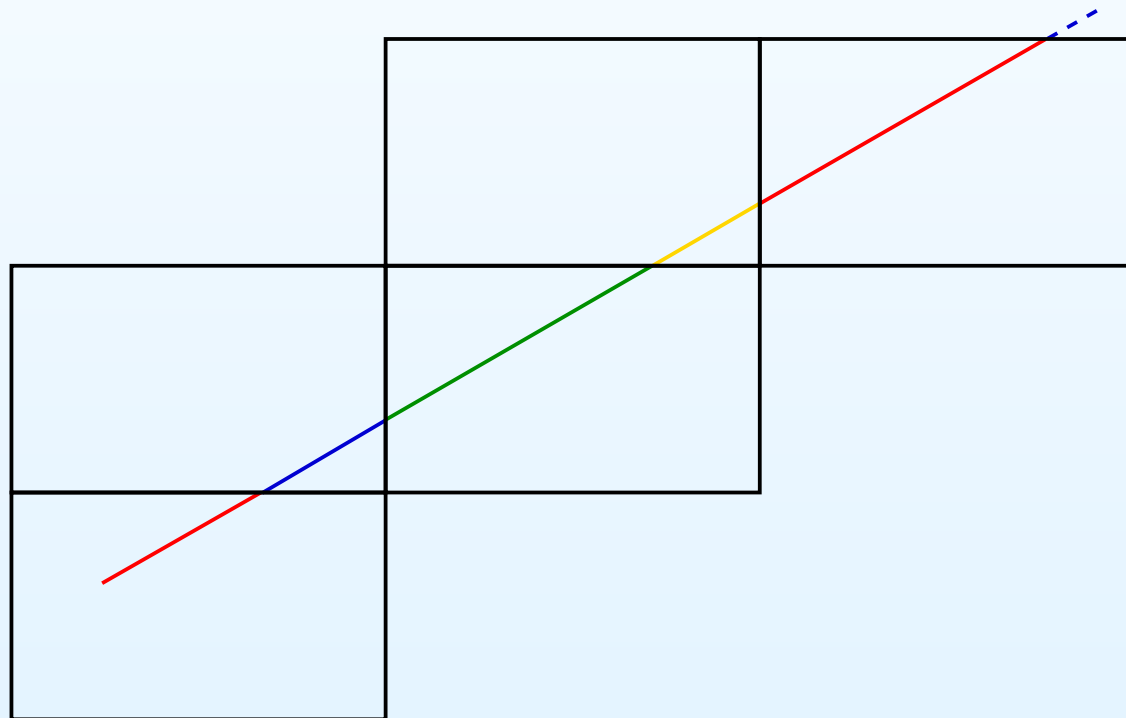

From billiards to surface foliations

Consider a rectangular billiard. Instead of reflecting the trajectory we can reflect the billiard table. The trajectory unfolds to a straight line. **Folding back the copies of the billiard table we project this line to the original trajectory.** At any moment the ball moves in one of four directions defining four types of copies of the billiard table. Copies of the same type are related by a parallel translation.

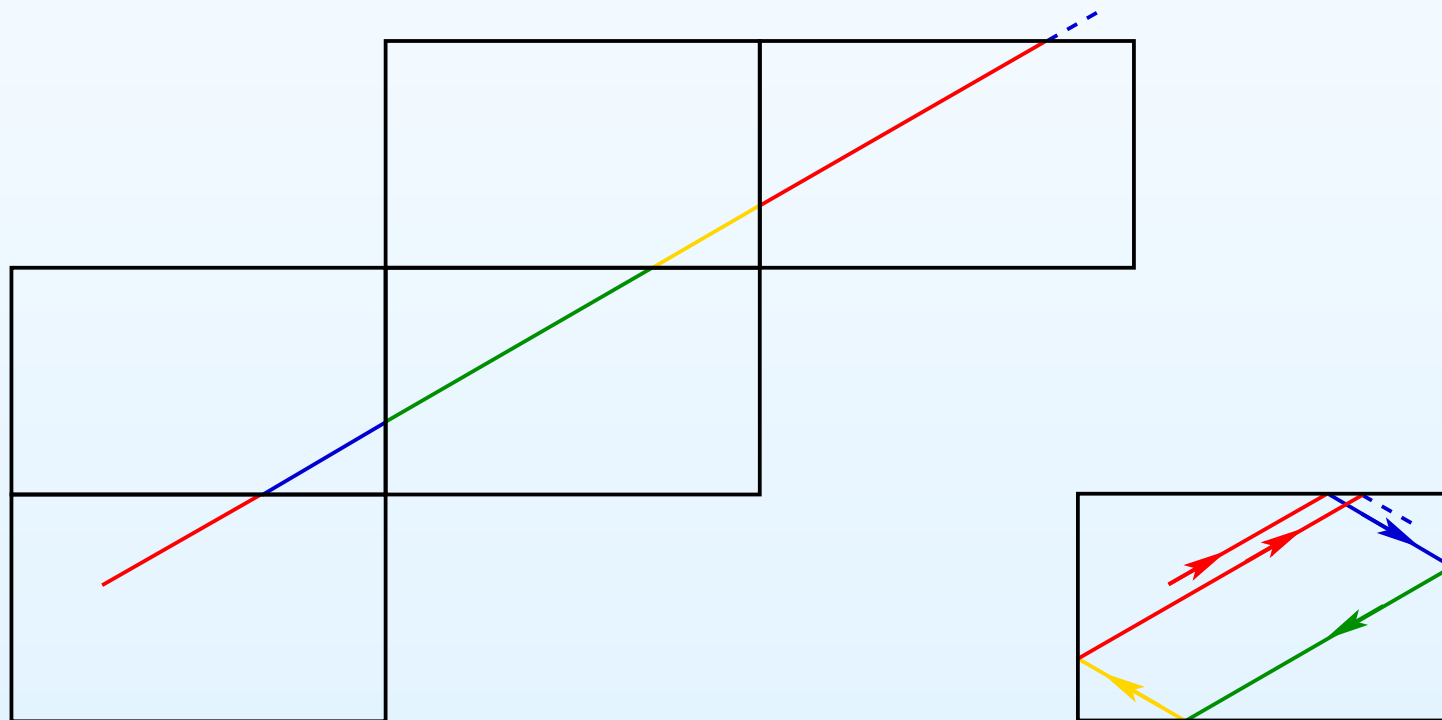

From billiards to surface foliations

Consider a rectangular billiard. Instead of reflecting the trajectory we can reflect the billiard table. The trajectory unfolds to a straight line. Folding back the copies of the billiard table we project this line to the original trajectory. At any moment the ball moves in one of four directions defining four types of copies of the billiard table. Copies of the same type are related by a parallel translation.

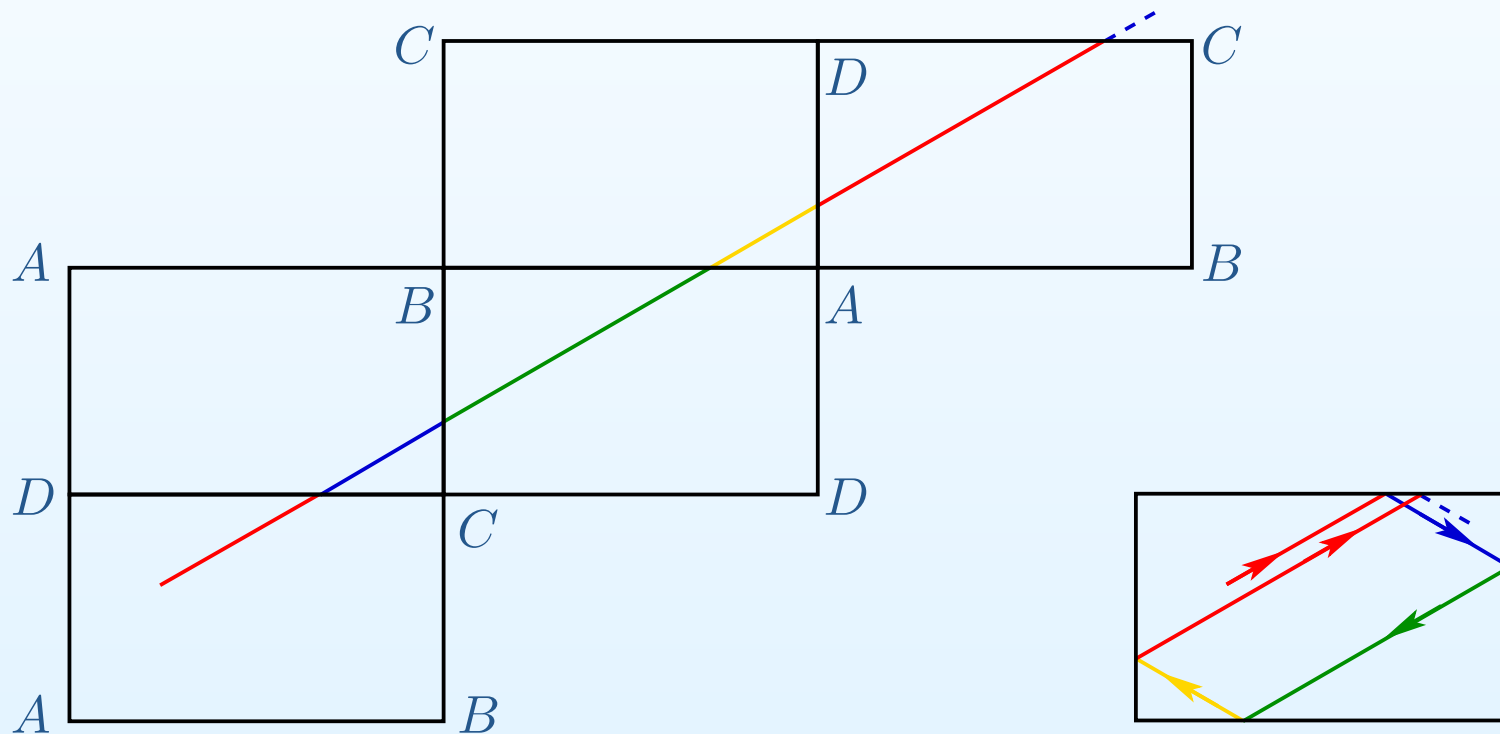

From billiards to surface foliations

Consider a rectangular billiard. Instead of reflecting the trajectory we can reflect the billiard table. The trajectory unfolds to a straight line. Folding back the copies of the billiard table we project this line to the original trajectory. At any moment the ball moves in one of four directions defining four types of copies of the billiard table. Copies of the same type are related by a parallel translation.

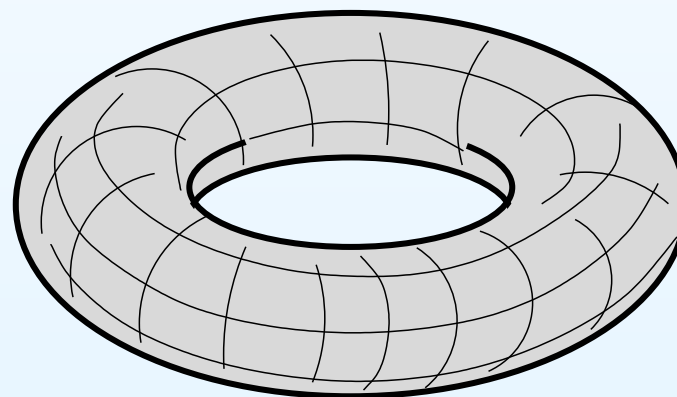
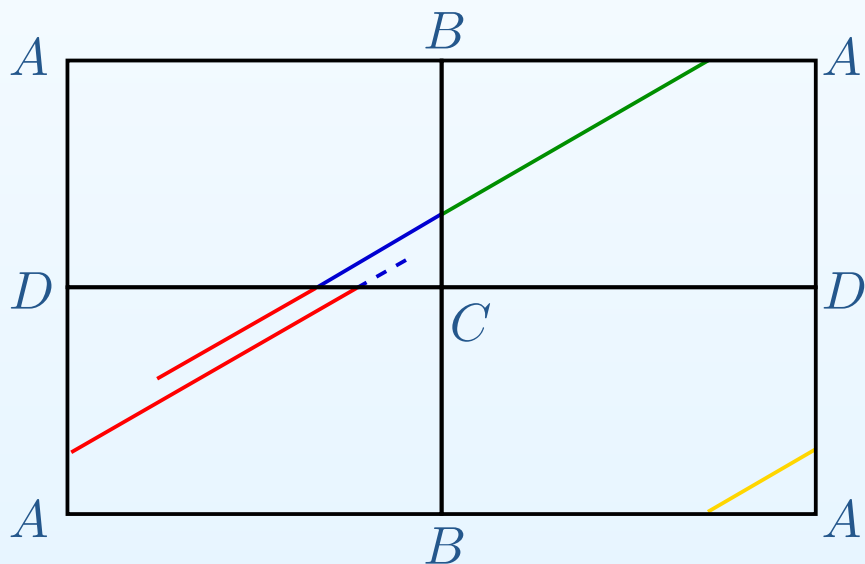

Identifying the equivalent patterns by a parallel translation we obtain a torus; the billiard trajectory unfolds to a “straight line” on the corresponding torus.

From billiards to surface foliations

Consider a rectangular billiard. Instead of reflecting the trajectory we can reflect the billiard table. The trajectory unfolds to a straight line. Folding back the copies of the billiard table we project this line to the original trajectory. At any moment the ball moves in one of four directions defining four types of copies of the billiard table. Copies of the same type are related by a parallel translation.

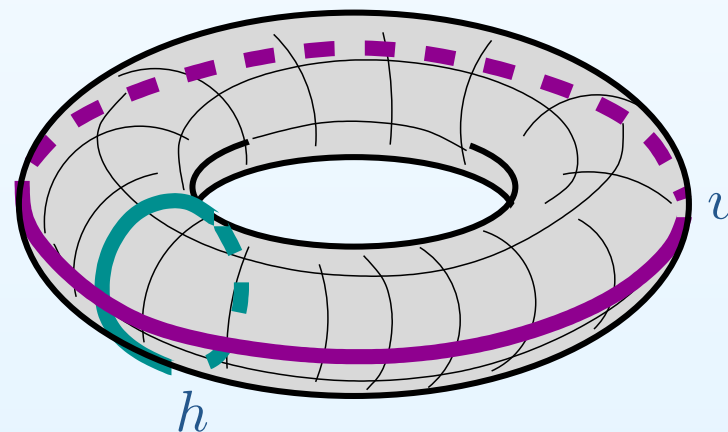
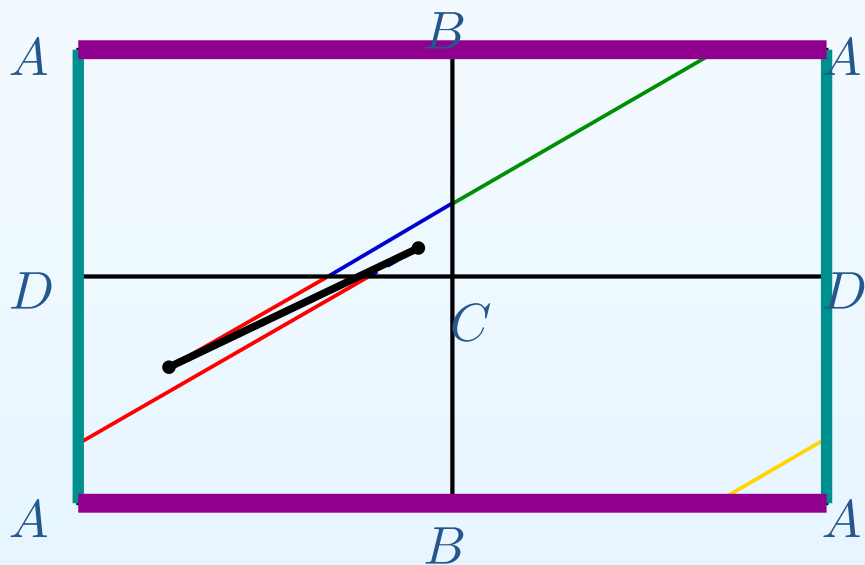

Join the endpoints of a piece of trajectory after time t to obtain a closed loop $c(t)$ on the torus. Vertical and horizontal displacement after time t of the unfolded billiard trajectory is described by the intersection numbers $c(t) \circ h$ and $c(t) \circ v$ with a parallel h and a meridian v of the torus.

Periodic billiards

Why billiards?

- Billiards in polygons
- Motivation for studying billiards
- Gas of two molecules
- Closed billiard trajectories
- Challenge
- Unfolding billiard trajectories
- Flat surfaces
- Flat metric with trivial holonomy

From billiards to surface foliations

Very flat surfaces

Why billiards?

Billiards in polygons

Following Moon Duchin let us play billiard in a polygon which might be more sophisticated than a usual rectangle.

Actually, we assume that a ball is very small, the walls do not have any holes, that there is no friction, and that the reflections are ideal and follow the rules of optic.



Motivation to study billiards: gas of two molecules in a one-dimensional chamber

Consider two elastic balls (“molecules”) sliding along a rod. They are bounded from two sides by solid walls. All collisions are ideal — without loss of energy.

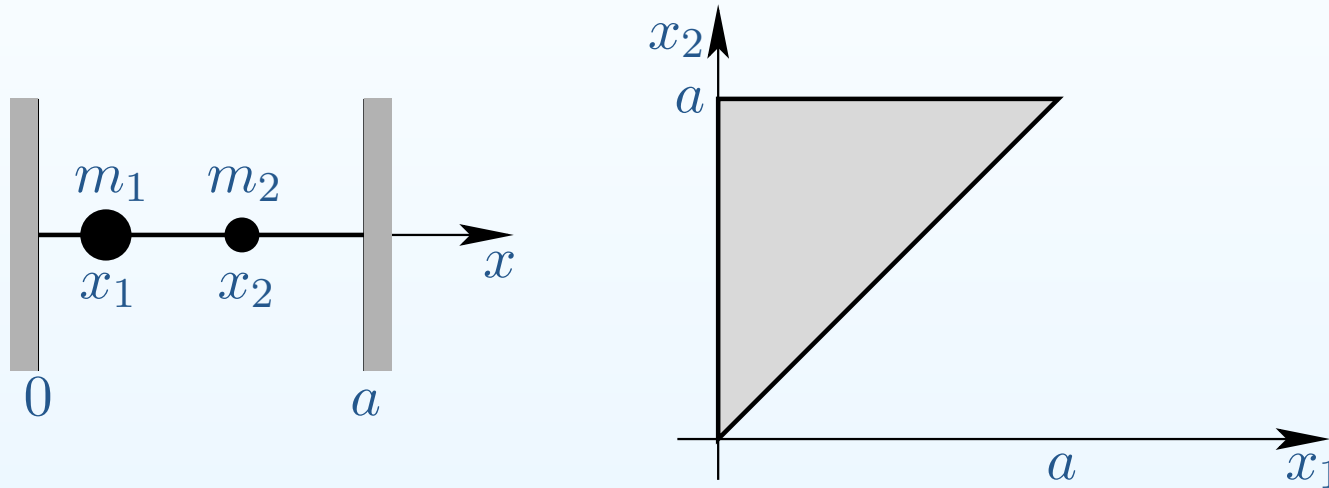

Motivation to study billiards: gas of two molecules in a one-dimensional chamber

Consider two elastic balls (“molecules”) sliding along a rod. They are bounded from two sides by solid walls. All collisions are ideal — without loss of energy.

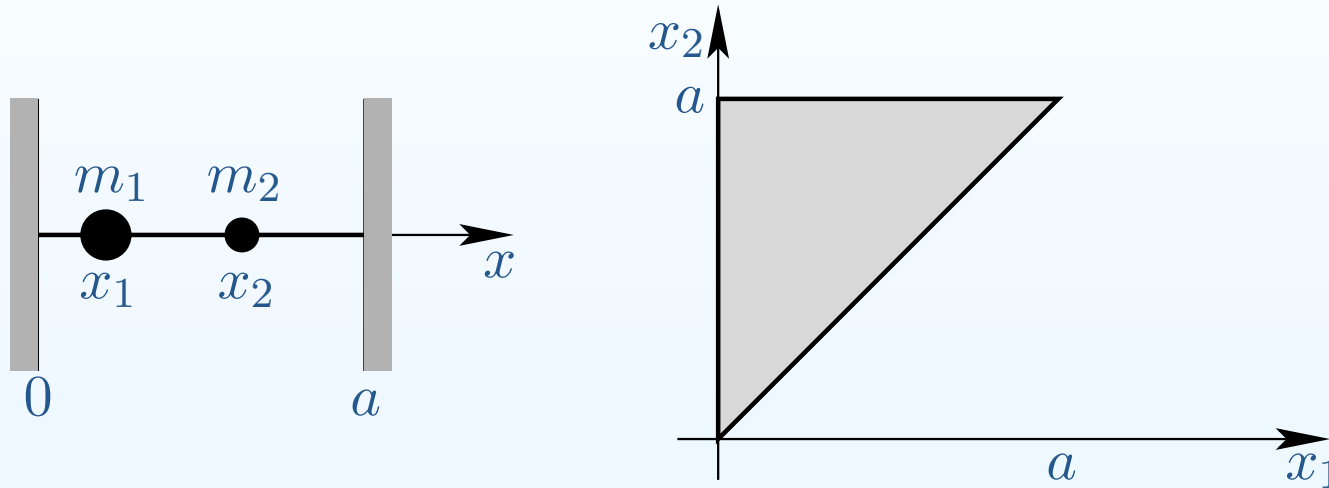

Neglecting the sizes of the balls we can describe the configuration space of our system using coordinates $0 < x_1 \leq x_2 \leq a$ of the balls, where a is the distance between the walls. This gives a right isosceles triangle.

Gas of two molecules

Rescaling the coordinates by square roots of masses

$$\begin{cases} \tilde{x}_1 = \sqrt{m_1}x_1 \\ \tilde{x}_2 = \sqrt{m_2}x_2 \end{cases}$$

we get a new right triangle Δ as a configuration space.

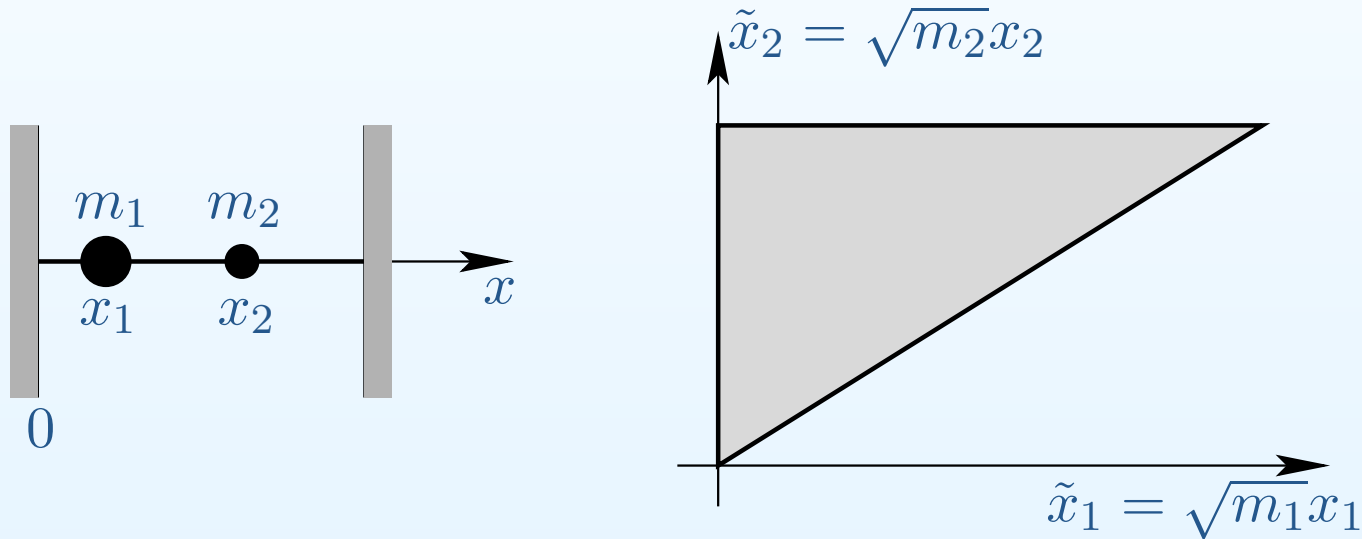

Gas of two molecules

Rescaling the coordinates by square roots of masses

$$\begin{cases} \tilde{x}_1 = \sqrt{m_1}x_1 \\ \tilde{x}_2 = \sqrt{m_2}x_2 \end{cases}$$

we get a new right triangle Δ as a configuration space.

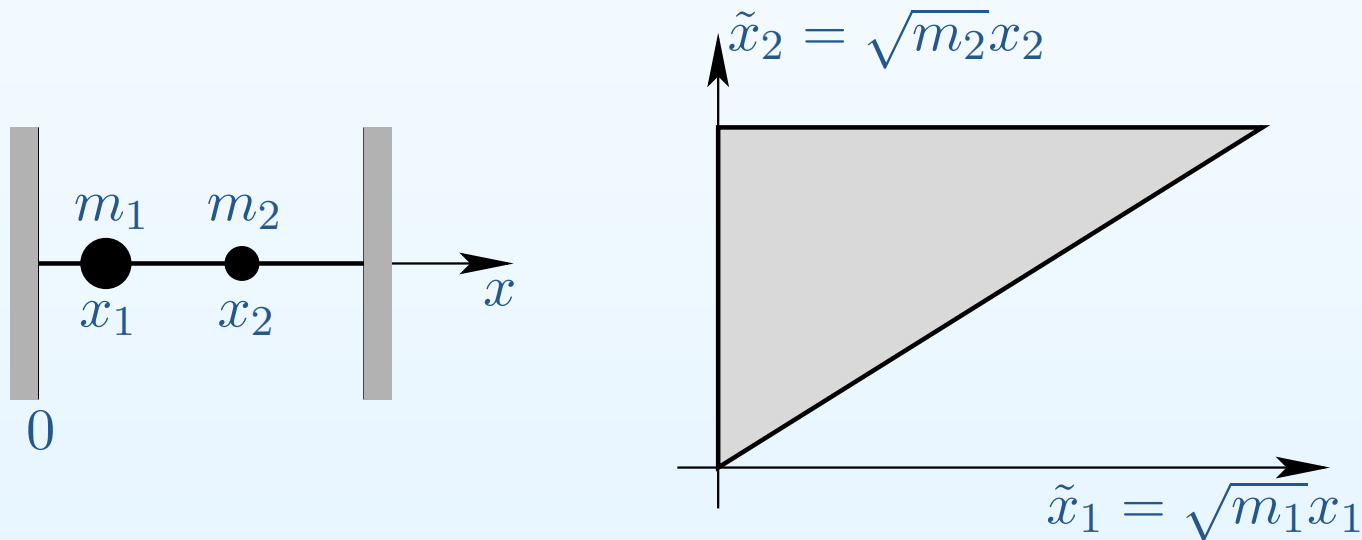

Lemma *In coordinates $(\tilde{x}_1, \tilde{x}_2)$ trajectories of the system of two balls on a rod correspond to billiard trajectories in the triangle Δ .*

Closed billiard trajectories

It is easy to find a periodic trajectory in an acute triangle:

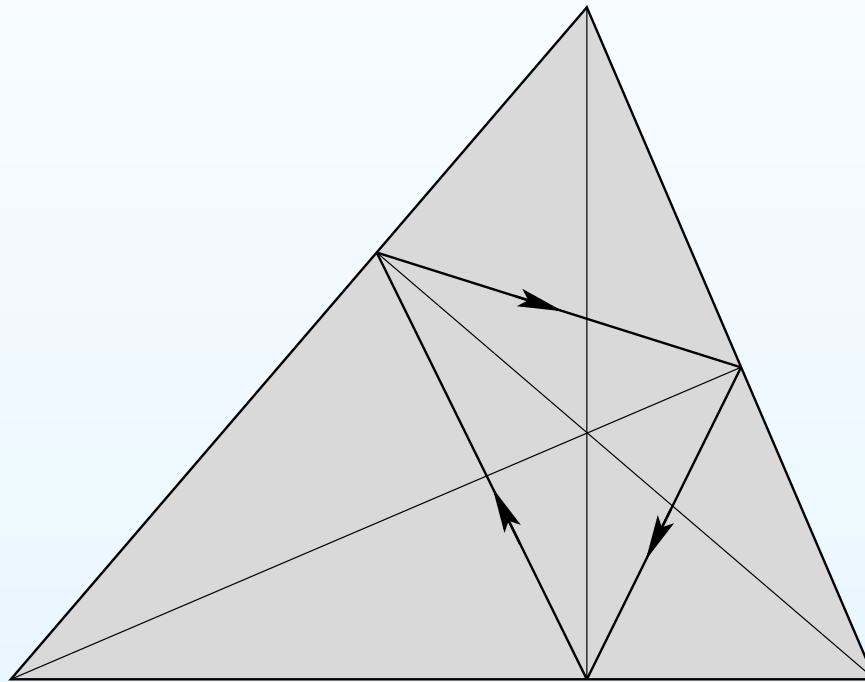

Exercise. Show that the broken line joining the base points of the heights in an acute triangle is a closed billiard trajectory (called *Fagnano trajectory*). Show that it is an inscribed triangle of the minimal possible perimeter.

Challenge

It is difficult to believe, but for an obtuse triangle the problem is open:

Open Problem. *Is there at least one periodic trajectory in any obtuse triangle?*

Challenge

It is difficult to believe, but for an obtuse triangle the problem is open:

Open Problem. *Is there at least one periodic trajectory in any obtuse triangle?*

The answer might be affirmative (for triangles with obtuse angle at most 100° R. Schwartz has verified it by a rigorous heavily computer-assisted proof).

Challenge

It is difficult to believe, but for an obtuse triangle the problem is open:

Open Problem. *Is there at least one periodic trajectory in any obtuse triangle?*

The answer might be affirmative (for triangles with obtuse angle at most 100° R. Schwartz has verified it by a rigorous heavily computer-assisted proof). But even if it is affirmative, the natural question “And how many?..” is completely and desperately open already for acute triangles.

Open Problem. *Estimate the number $N(\Pi, L)$ of periodic trajectories of length at most L in a polygon Π as $L \rightarrow +\infty$.*

Open Problem. *Is the billiard flow ergodic for almost any triangle?*

Unfolding billiard trajectories

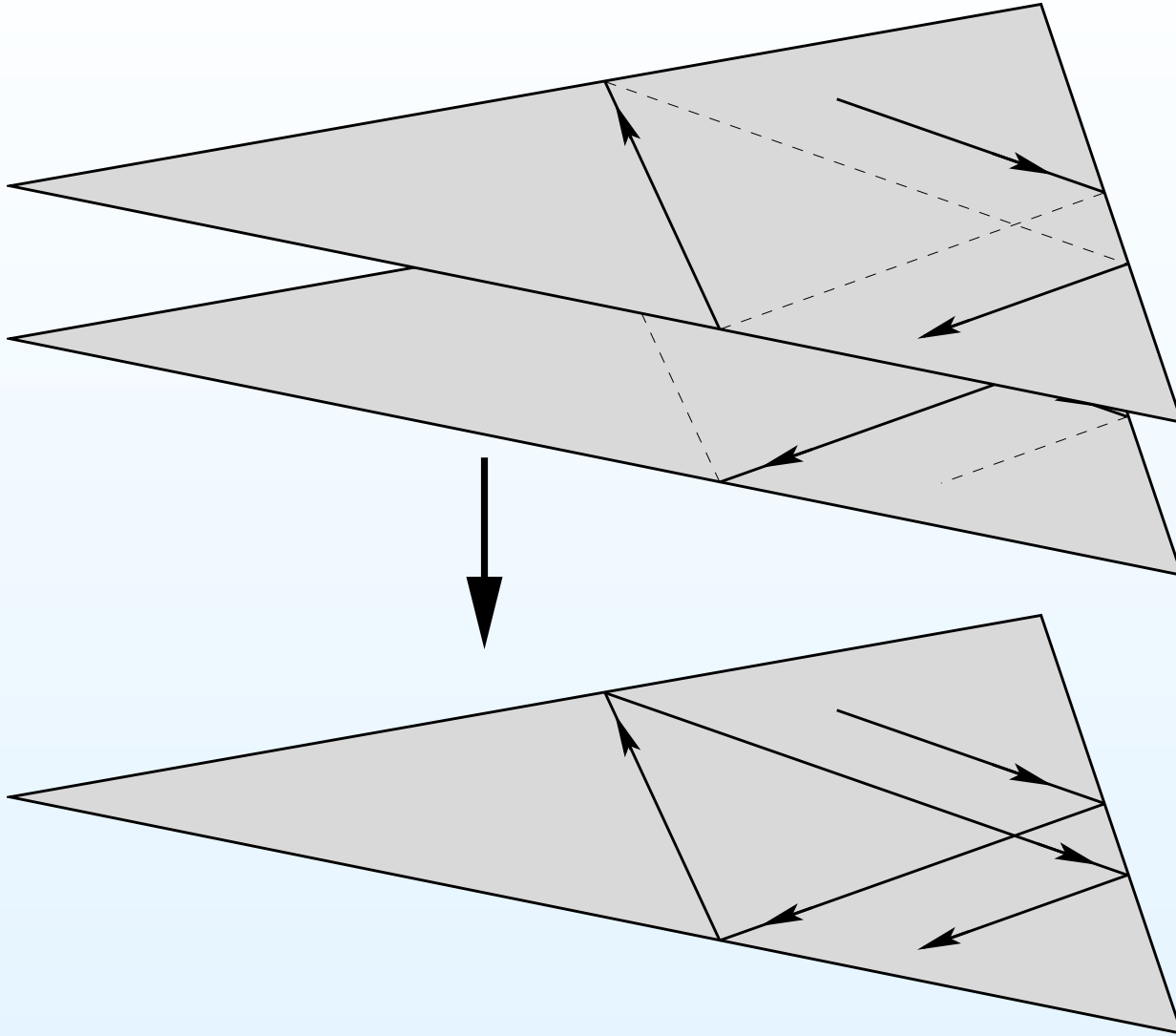

Identifying the boundary of two triangles we get a flat sphere. A billiard trajectory unfolds to a geodesic on this flat sphere.

Flat surfaces

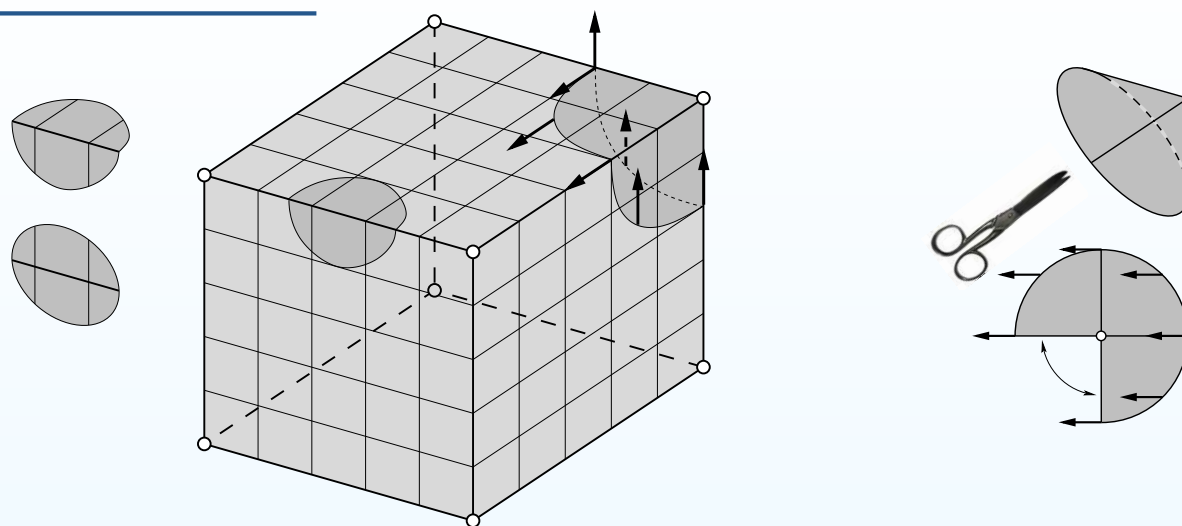

The surface of the cube represents a flat sphere with eight conical singularities. The metric *does not* have singularities on the edges. After parallel transport around a conical singularity a vector comes back pointing to a direction different from the initial one, so this flat metric has *nontrivial holonomy*. The nontrivial holonomy allows, in particular, to generic geodesics to have self-intersections.

Flat metric with trivial holonomy

A flat torus provides an example of a flat surface with *trivial holonomy*. Having defined a direction to the North at one point of a flat torus, we can spread it to all other points. A geodesic sent to, say, North-West-West direction will always go in the North-West-West direction. We will construct now further examples of such “very flat surfaces”.

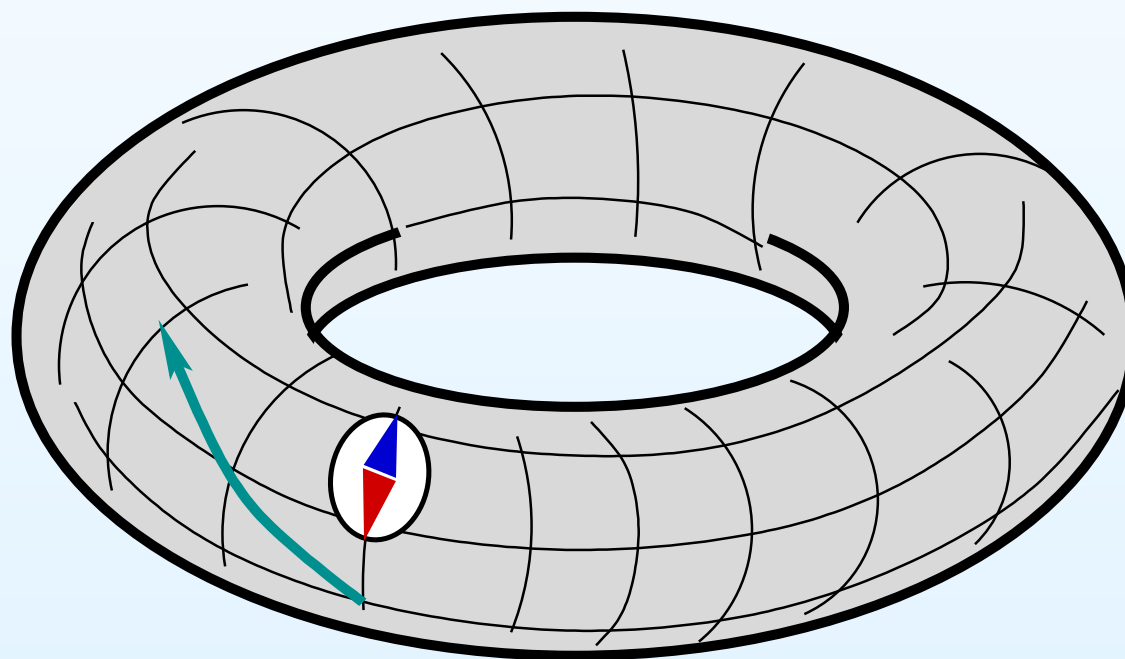

Periodic billiards

Why billiards?

From billiards to surface
foliations

- Unfolding rational billiards
- Very flat surface of genus 2
- Windtree flat surface
- Surfaces which are more flat than the others
- Outline of the story

Very flat surfaces

From billiards to surface foliations

Unfolding rational billiards

We can apply an unfolding procedure (which was already applied to a rectangular billiard) to *any* rational billiard.

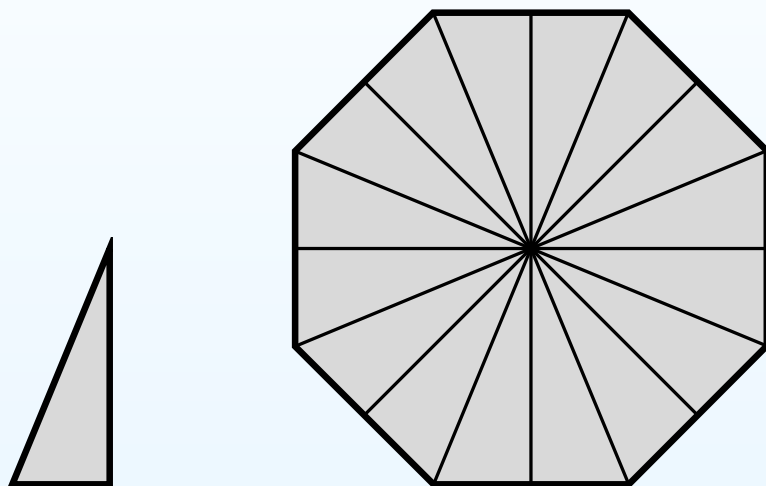

Consider, for example, a triangle with angles $\pi/8, 3\pi/8, \pi/2$. It is easy to check that a generic trajectory in such billiard table has 16 directions (instead of 4 for a rectangle). Using 16 copies of the triangle we unfold the billiard into a regular octagon with opposite sides identified by parallel translations.

Very flat surface of genus 2

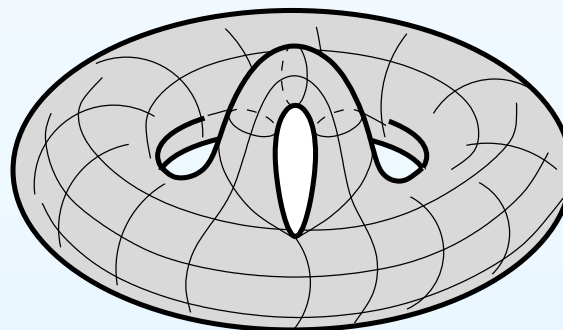
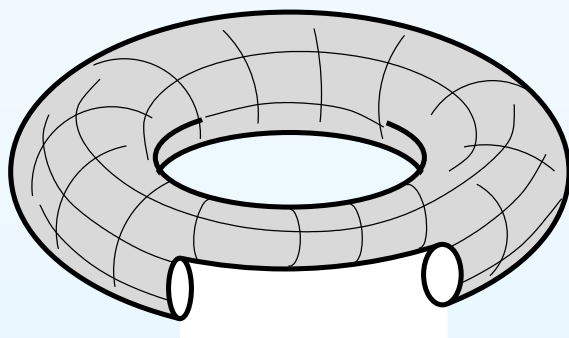
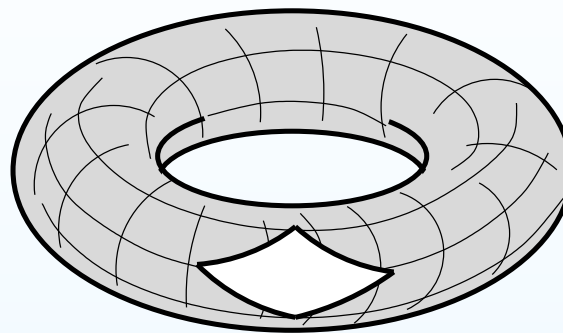
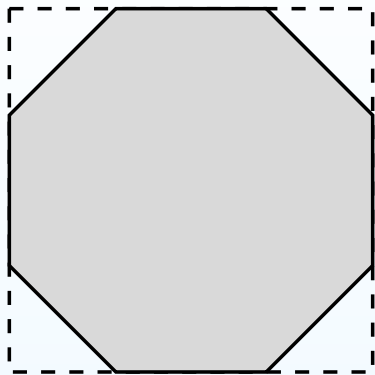

Identifying the opposite sides of a regular octagon we get a flat surface of genus two. All the vertices of the octagon are identified into a single conical singularity. We always consider such a flat surface endowed with a distinguished (say, vertical) direction. By construction, the holonomy of the flat metric is trivial. Thus, the vertical direction at a single point globally defines vertical and horizontal foliations.

Very flat surface of genus 2

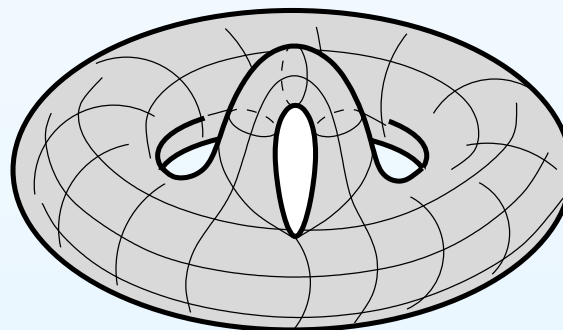
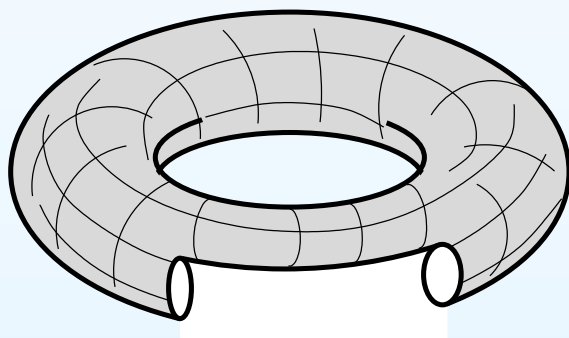
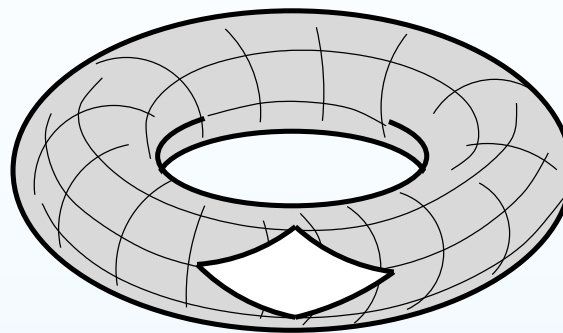
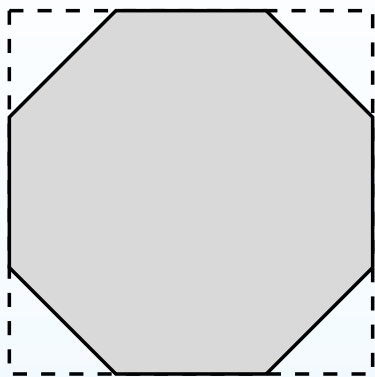

Identifying the opposite sides of a regular octagon we get a flat surface of genus two. All the vertices of the octagon are identified into a single conical singularity. We always consider such a flat surface endowed with a distinguished (say, vertical) direction. By construction, the holonomy of the flat metric is trivial. Thus, the vertical direction at a single point globally defines vertical and horizontal foliations.

Very flat surface of genus 2

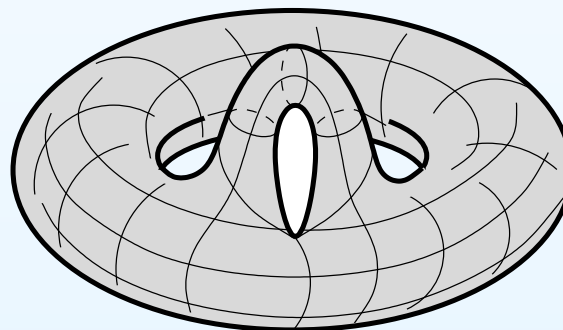
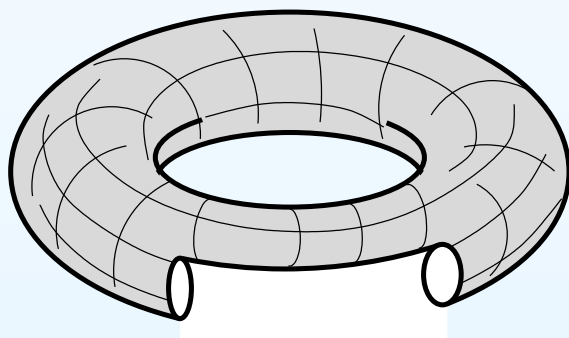
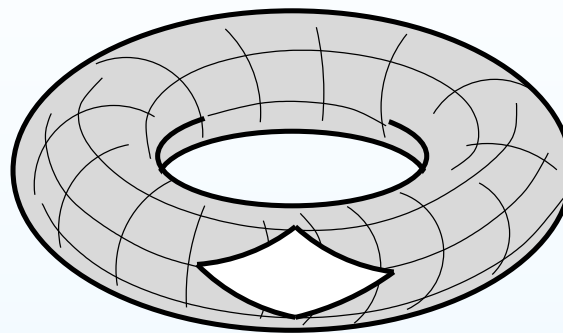
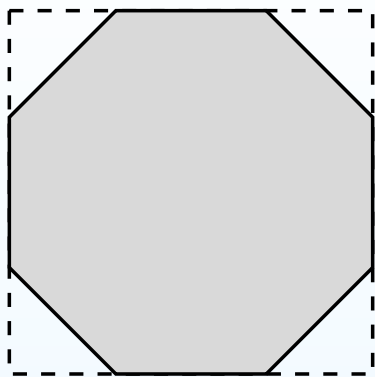

Identifying the opposite sides of a regular octagon we get a flat surface of genus two. All the vertices of the octagon are identified into a single conical singularity. We always consider such a flat surface endowed with a distinguished (say, vertical) direction. By construction, the holonomy of the flat metric is trivial. Thus, the vertical direction at a single point globally defines vertical and horizontal foliations.

Windtree flat surface

Similarly, taking four copies of our \mathbb{Z}^2 -periodic windtree billiard we can unfold it to a foliation on a \mathbb{Z}^2 -periodic surface. Taking a quotient over \mathbb{Z}^2 we get a compact surface endowed with a measured foliation. Vertical and horizontal displacement (and thus, the diffusion) of billiard trajectories is described by the intersection numbers $c(t) \circ h$ and $c(t) \circ v$ of the cycle $c(t)$ obtained by closing up a long piece of leaf with a “parallel” h and a “meridian” v . Here $h = h_{00} + h_{10} - h_{01} - h_{11}$ and $v = v_{00} - v_{10} + v_{01} - v_{11}$.

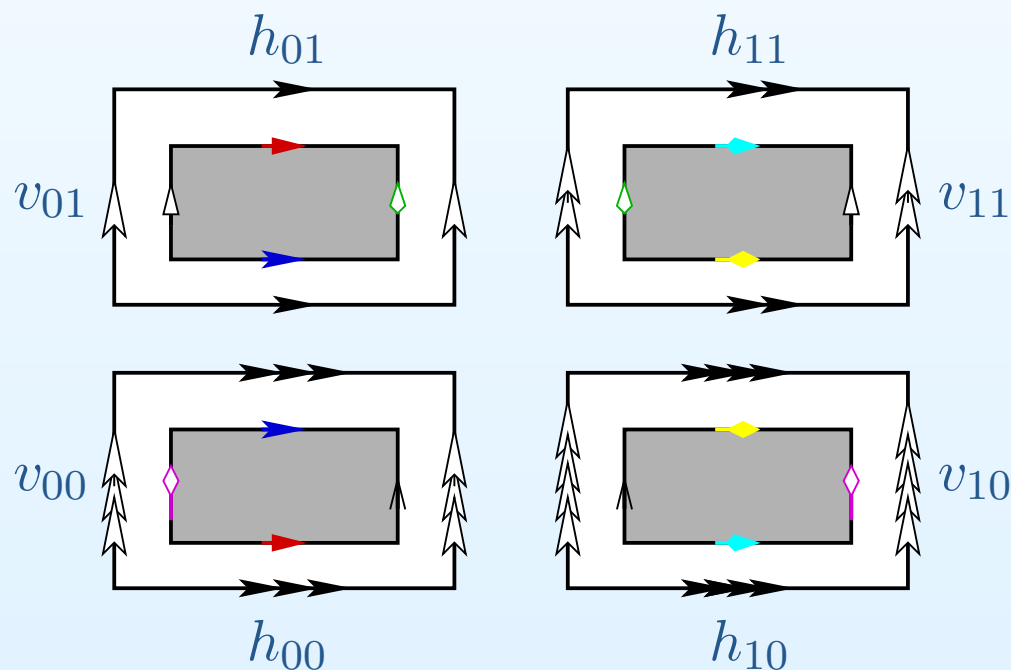

Surfaces which are more flat than the others

Note that the flat metric on the resulting surface has *trivial holonomy*, since the identifications of the sides were performed by parallel translations. As before, a billiard trajectory is unfolded to a geodesic on the surface. Note that geodesics resemble geodesics on the torus: they do not have self-intersections!

Surfaces which are more flat than the others

Note that the flat metric on the resulting surface has *trivial holonomy*, since the identifications of the sides were performed by parallel translations. As before, a billiard trajectory is unfolded to a geodesic on the surface. Note that geodesics resemble geodesics on the torus: they do not have self-intersections!

We abandon rational billiards for a while and pass to a more systematic study of “*very flat*” surfaces.

Outline of the story

Billiards in polygons, straight line foliations on flat surfaces, horocyclic flows on homogeneous spaces exhibit unusual behaviour of natural mean value quantities.

The corresponding *deviation spectrum* — a finite collection of numbers generalizing the diffusion rate $\frac{2}{3}$ in the windtree model, can be found studying the renormalized dynamical system: the *Teichmüller geodesic flow* acting on the moduli space of quadratic differentials. The fact that one can compute (or estimate) the corresponding numbers comes from a beautiful interplay:

Dynamically, the moduli space of quadratic differentials pretends to be a homogeneous space: Eskin–Mirzakhani-Mohammadi have recently proved certain striking rigidity results (specific for homogeneous case).

Hodge theory provides rich geometric structure relating Lyapunov exponents and characteristic numbers of holomorphic vector bundles over certain loci in the moduli space first noticed by Maxim Kontsevich and by Giovanni Forni.

Outline of the story

Billiards in polygons, straight line foliations on flat surfaces, horocyclic flows on homogeneous spaces exhibit unusual behaviour of natural mean value quantities.

The corresponding *deviation spectrum* — a finite collection of numbers generalizing the diffusion rate $\frac{2}{3}$ in the windtree model, can be found studying the renormalized dynamical system: the *Teichmüller geodesic flow* acting on the moduli space of quadratic differentials. The fact that one can compute (or estimate) the corresponding numbers comes from a beautiful interplay:

Dynamically, the moduli space of quadratic differentials pretends to be a homogeneous space: Eskin–Mirzakhani-Mohammadi have recently proved certain striking rigidity results (specific for homogeneous case).

Hodge theory provides rich geometric structure relating Lyapunov exponents and characteristic numbers of holomorphic vector bundles over certain loci in the moduli space first noticed by Maxim Kontsevich and by Giovanni Forni.

Outline of the story

Billiards in polygons, straight line foliations on flat surfaces, horocyclic flows on homogeneous spaces exhibit unusual behaviour of natural mean value quantities.

The corresponding *deviation spectrum* — a finite collection of numbers generalizing the diffusion rate $\frac{2}{3}$ in the windtree model, can be found studying the renormalized dynamical system: the *Teichmüller geodesic flow* acting on the moduli space of quadratic differentials. The fact that one can compute (or estimate) the corresponding numbers comes from a beautiful interplay:

Dynamically, the moduli space of quadratic differentials pretends to be a homogeneous space: Eskin–Mirzakhani-Mohammadi have recently proved certain striking rigidity results (specific for homogeneous case).

Hodge theory provides rich geometric structure relating Lyapunov exponents and characteristic numbers of holomorphic vector bundles over certain loci in the moduli space first noticed by Maxim Kontsevich and by Giovanni Forni.

Outline of the story

Billiards in polygons, straight line foliations on flat surfaces, horocyclic flows on homogeneous spaces exhibit unusual behaviour of natural mean value quantities.

The corresponding *deviation spectrum* — a finite collection of numbers generalizing the diffusion rate $\frac{2}{3}$ in the windtree model, can be found studying the renormalized dynamical system: the *Teichmüller geodesic flow* acting on the moduli space of quadratic differentials. The fact that one can compute (or estimate) the corresponding numbers comes from a beautiful interplay:

Dynamically, the moduli space of quadratic differentials pretends to be a homogeneous space: Eskin–Mirzakhani-Mohammadi have recently proved certain striking rigidity results (specific for homogeneous case).

Hodge theory provides rich geometric structure relating Lyapunov exponents and characteristic numbers of holomorphic vector bundles over certain loci in the moduli space first noticed by Maxim Kontsevich and by Giovanni Forni.

Periodic billiards

Why billiards?

From billiards to surface
foliations

Very flat surfaces

- Very flat surfaces:
construction from a
polygon
- Properties of very flat
surfaces
- Conical singularity
- Families of flat
surfaces
- Space of lattices
- Family of flat tori
- Joueurs de billard

Very flat surfaces

Very flat surfaces: construction from a polygon

Consider a broken line constructed from vectors $\vec{v}_1, \dots, \vec{v}_k$.

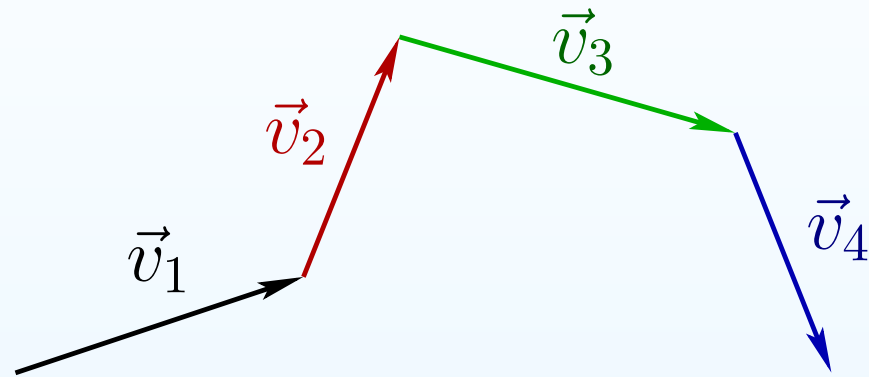

and another one constructed from the same vectors taken in another order.

Very flat surfaces: construction from a polygon

Consider a broken line constructed from vectors $\vec{v}_1, \dots, \vec{v}_k$.

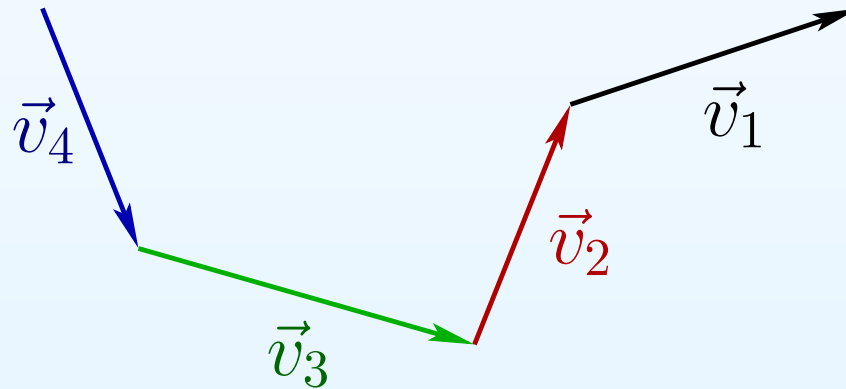

and another one constructed from the same vectors taken in another order.

Very flat surfaces: construction from a polygon

Consider a broken line constructed from vectors $\vec{v}_1, \dots, \vec{v}_k$.

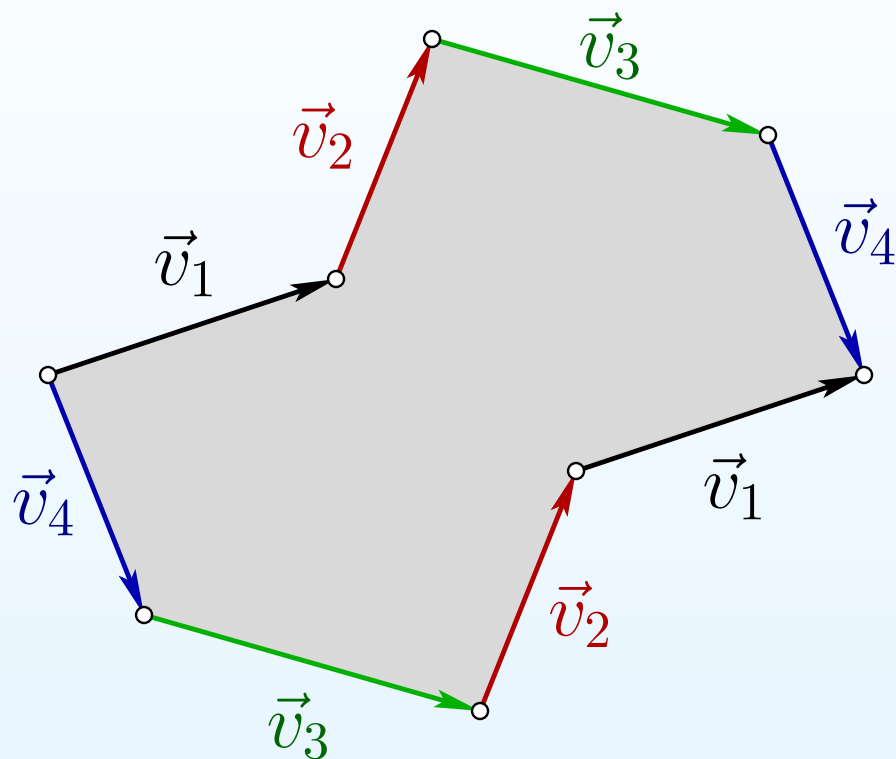

and another one constructed from the same vectors taken in another order. If we are lucky enough the two broken lines do not intersect and form a polygon.

Very flat surfaces: construction from a polygon

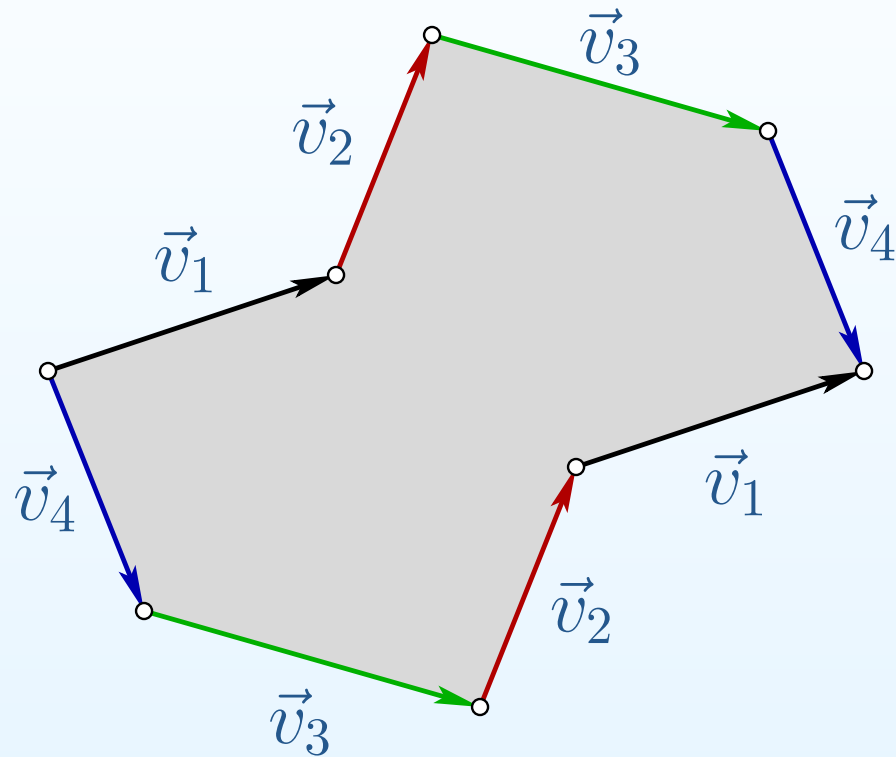

Identifying the corresponding pairs of sides by parallel translations we get a closed surface endowed with a flat metric.

Properties of very flat surfaces

- The flat metric is nonsingular outside of a finite number of conical singularities (inherited from the vertices of the polygon).
- The flat metric has trivial holonomy, i.e. parallel transport along any closed path brings a tangent vector to itself.
- In particular, all cone angles are integer multiples of 2π .

Properties of very flat surfaces

- The flat metric is nonsingular outside of a finite number of conical singularities (inherited from the vertices of the polygon).
- The flat metric has trivial holonomy, i.e. parallel transport along any closed path brings a tangent vector to itself.
- In particular, all cone angles are integer multiples of 2π .

Properties of very flat surfaces

- The flat metric is nonsingular outside of a finite number of conical singularities (inherited from the vertices of the polygon).
- The flat metric has trivial holonomy, i.e. parallel transport along any closed path brings a tangent vector to itself.
- In particular, all cone angles are integer multiples of 2π .

Properties of very flat surfaces

- The flat metric is nonsingular outside of a finite number of conical singularities (inherited from the vertices of the polygon).
- The flat metric has trivial holonomy, i.e. parallel transport along any closed path brings a tangent vector to itself.
- In particular, all cone angles are integer multiples of 2π .
- By convention, the choice of the vertical direction (“direction to the North”) will be considered as a part of the “very flat structure”.
For example, a surface obtained from a rotated polygon is considered as a different very flat surface.

Properties of very flat surfaces

- The flat metric is nonsingular outside of a finite number of conical singularities (inherited from the vertices of the polygon).
- The flat metric has trivial holonomy, i.e. parallel transport along any closed path brings a tangent vector to itself.
- In particular, all cone angles are integer multiples of 2π .
- By convention, the choice of the vertical direction (“direction to the North”) will be considered as a part of the “very flat structure”.
For example, a surface obtained from a rotated polygon is considered as a different very flat surface.
- A conical singularity with the cone angle $2\pi \cdot N$ has N outgoing directions to the North.

Example: conical singularity with cone angle 6π

Locally a neighborhood of a conical point looks like a “*monkey saddle*”.

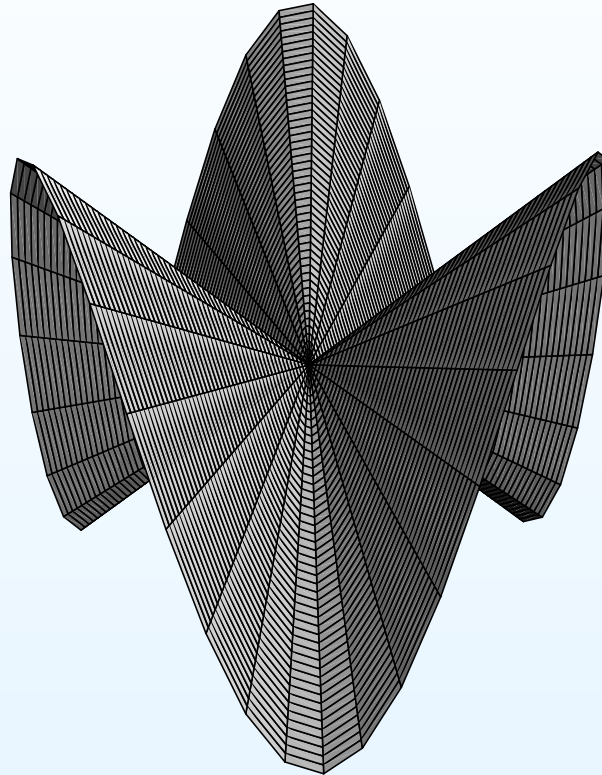

A neighborhood of a conical point with a cone angle 6π can be glued from six metric half discs. At this conical point we have 3 distinct directions to the North.

Families of flat surfaces

The polygon in our construction depends continuously on the vectors \vec{v}_j . This means that the combinatorial geometry of the resulting flat surface (its genus g , the number n and types $2\pi(d_1 + 1), \dots, 2\pi(d_n + 1)$ of the resulting conical singularities) does not change under small deformations of the vectors \vec{v}_j . This allows to consider a flat surface as an element of a **family** of flat surfaces sharing common combinatorial geometry.

As an example of such family one can consider a family of flat tori of area one, which can be identified with the space of lattices of area one:

$$\mathrm{SO}(2, \mathbb{R}) \backslash \mathrm{SL}(2, \mathbb{R}) / \mathrm{SL}(2, \mathbb{Z}) = \mathbb{H}^2 / \mathrm{SL}(2, \mathbb{Z})$$

Families of flat surfaces

The polygon in our construction depends continuously on the vectors \vec{v}_j . This means that the combinatorial geometry of the resulting flat surface (its genus g , the number n and types $2\pi(d_1 + 1), \dots, 2\pi(d_n + 1)$ of the resulting conical singularities) does not change under small deformations of the vectors \vec{v}_j . This allows to consider a flat surface as an element of a **family** of flat surfaces sharing common combinatorial geometry.

As an example of such family one can consider a family of flat tori of area one, which can be identified with the space of lattices of area one:

$$\mathrm{SO}(2, \mathbb{R}) \backslash \mathrm{SL}(2, \mathbb{R}) / \mathrm{SL}(2, \mathbb{Z}) = \mathbb{H}^2 / \mathrm{SL}(2, \mathbb{Z})$$

Space of lattices

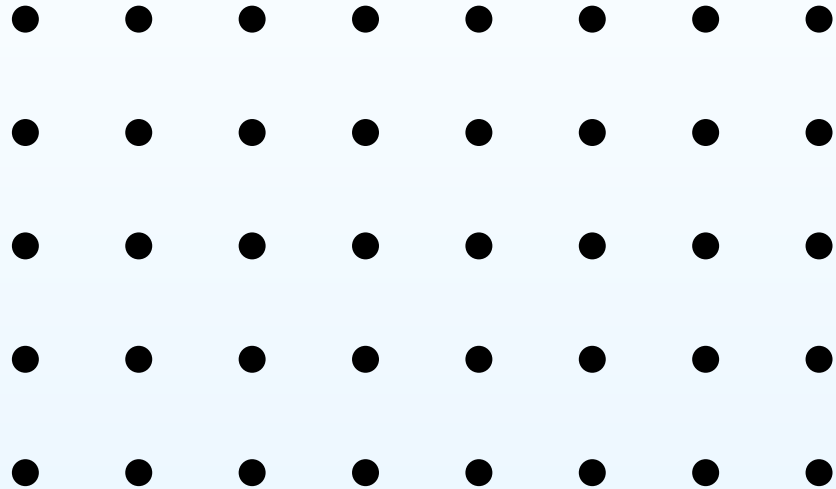

Instead of a single lattice consider a family of all lattices. We can continuously deform a lattice.

Space of lattices

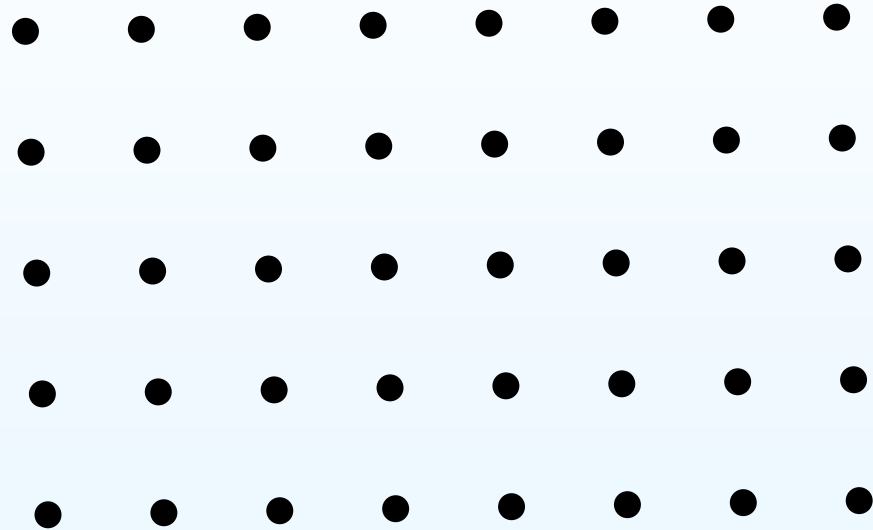

Instead of a single lattice consider a family of all lattices. We can continuously deform a lattice.

Space of lattices

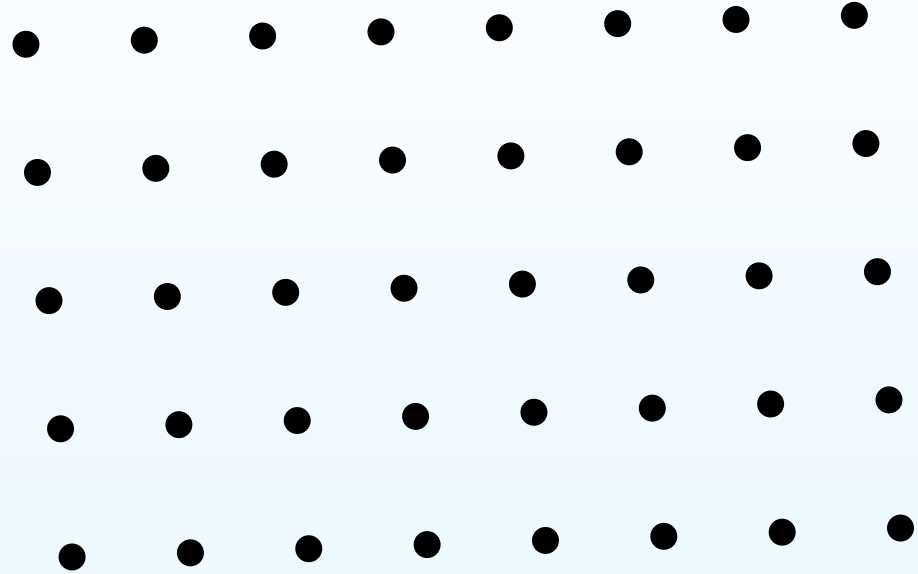

Instead of a single lattice consider a family of all lattices. We can continuously deform a lattice.

Space of lattices

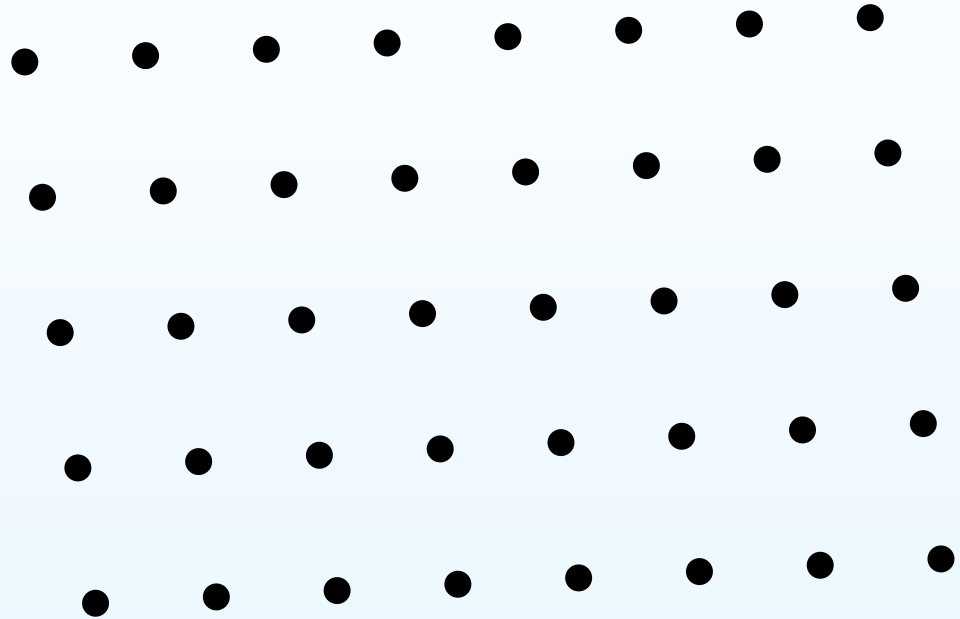

Instead of a single lattice consider a family of all lattices. We can continuously deform a lattice.

Space of lattices

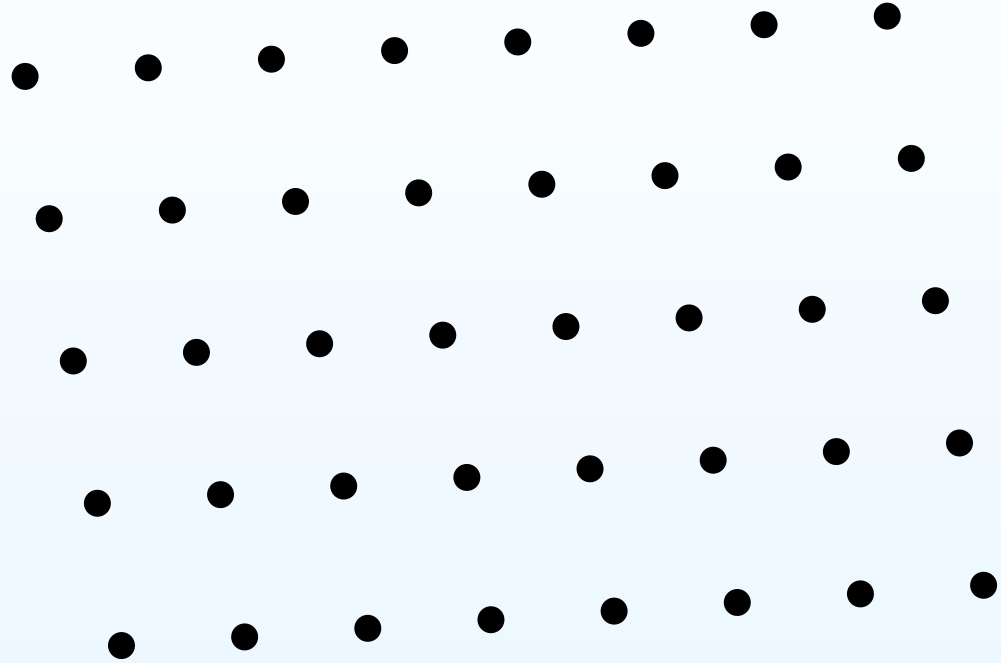

Instead of a single lattice consider a family of all lattices. We can continuously deform a lattice.

Space of lattices

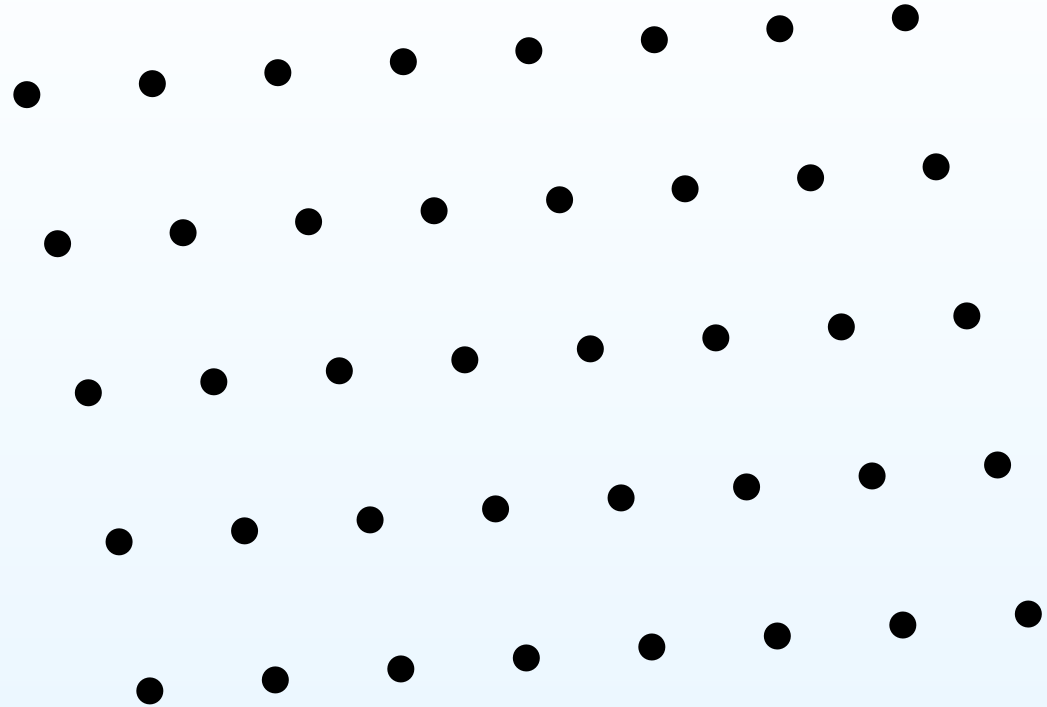

Instead of a single lattice consider a family of all lattices. We can continuously deform a lattice.

Space of lattices

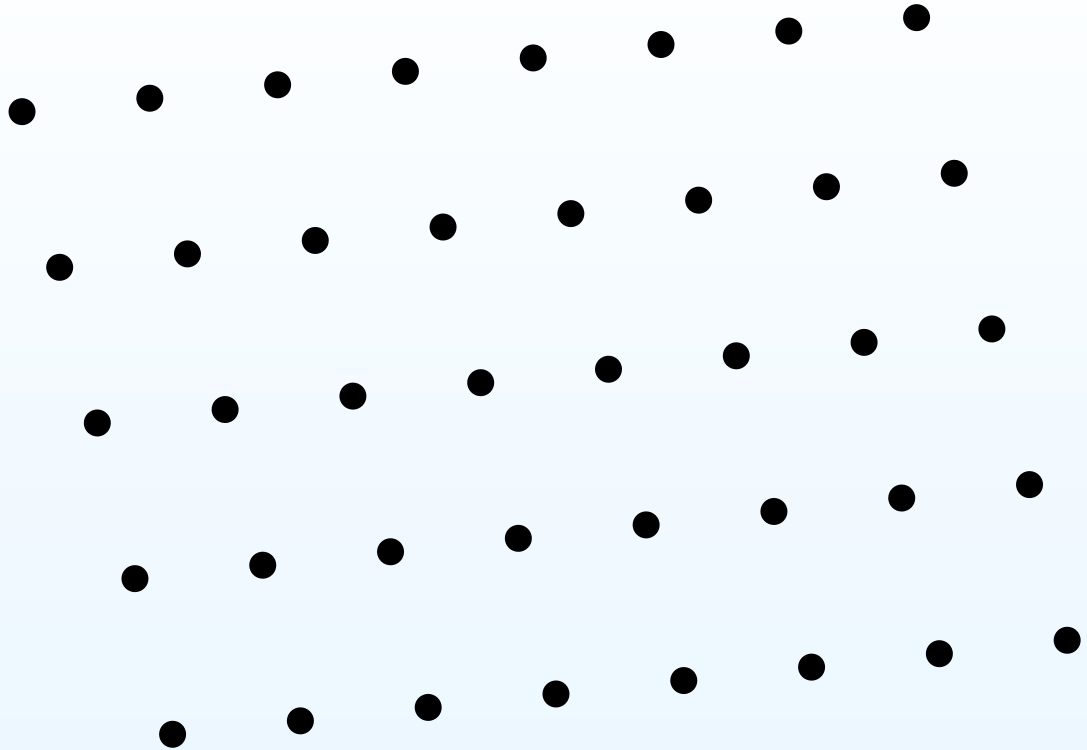

Instead of a single lattice consider a family of all lattices. We can continuously deform a lattice.

Space of lattices

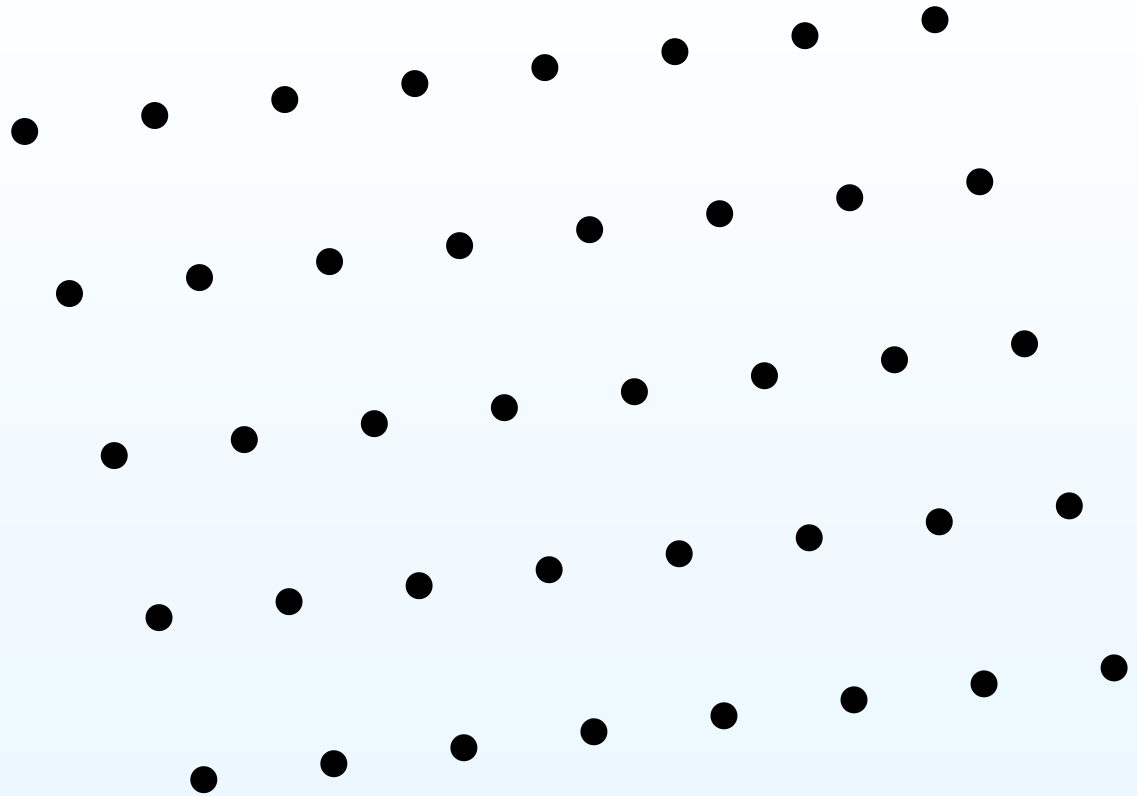

Instead of a single lattice consider a family of all lattices. We can continuously deform a lattice.

Space of lattices

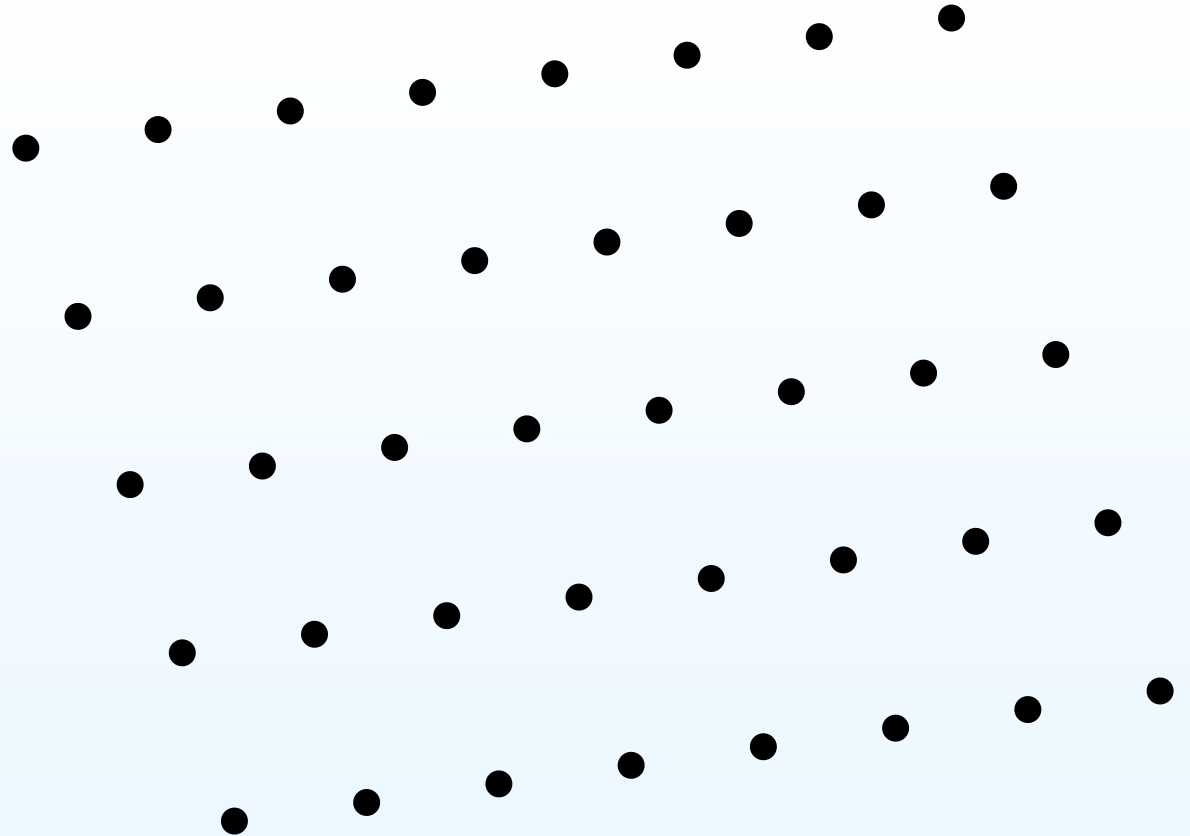

Instead of a single lattice consider a family of all lattices. We can continuously deform a lattice.

Space of lattices

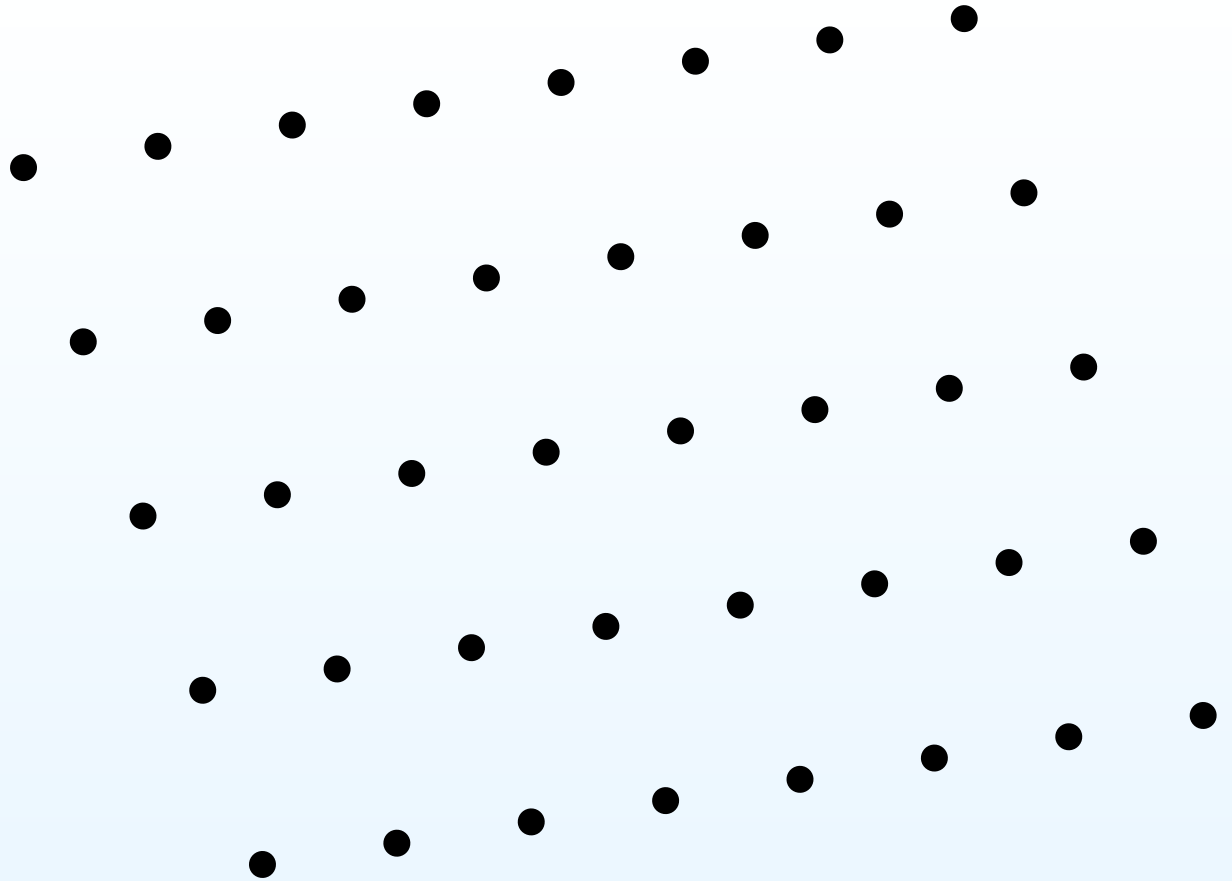

Instead of a single lattice consider a family of all lattices. We can continuously deform a lattice.

Space of lattices

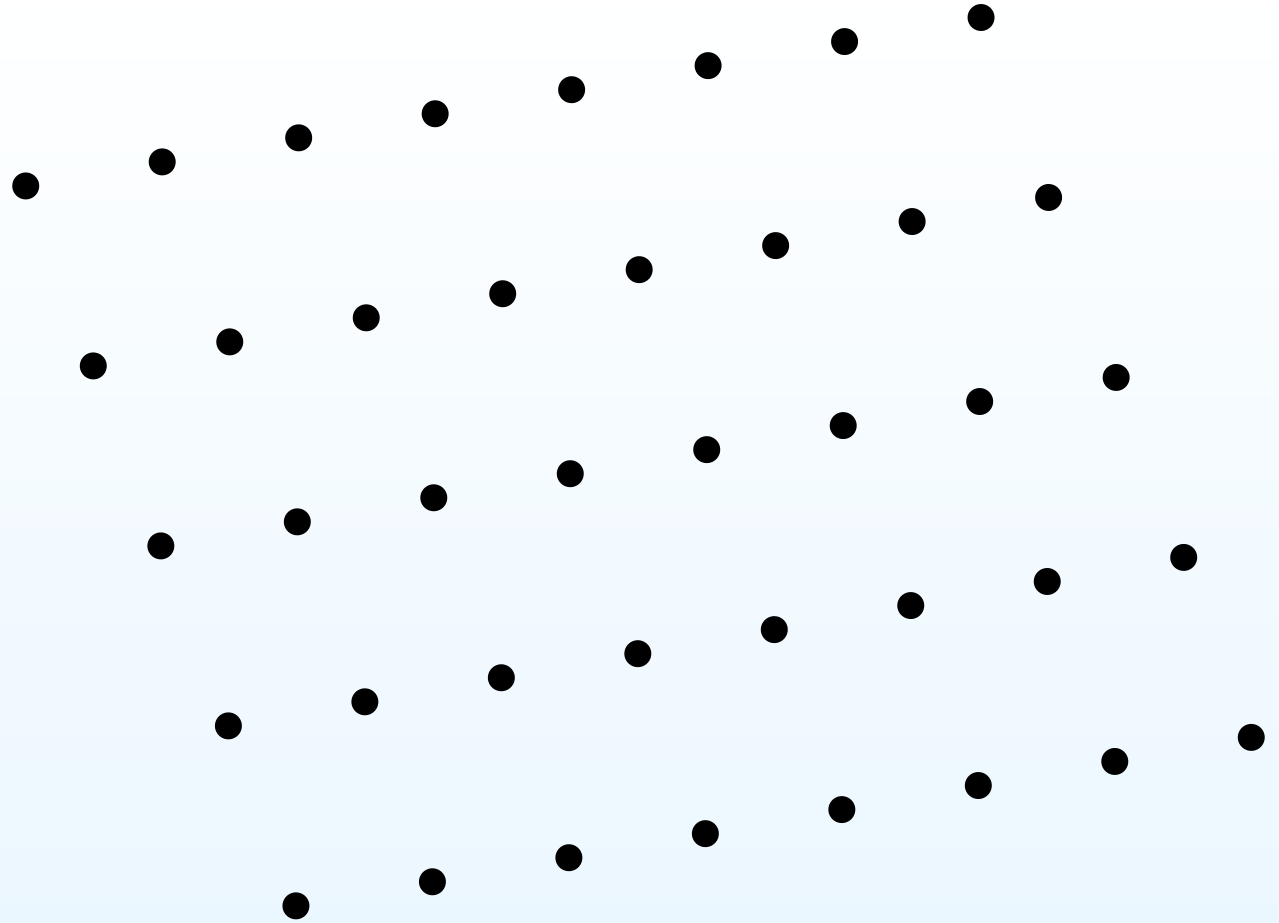

Instead of a single lattice consider a family of all lattices. We can continuously deform a lattice.

If we are interested only by the straight lines (geodesics) on the corresponding flat tori, we do not distinguish lattices which differ by a rotation or a homothety.

Space of lattices

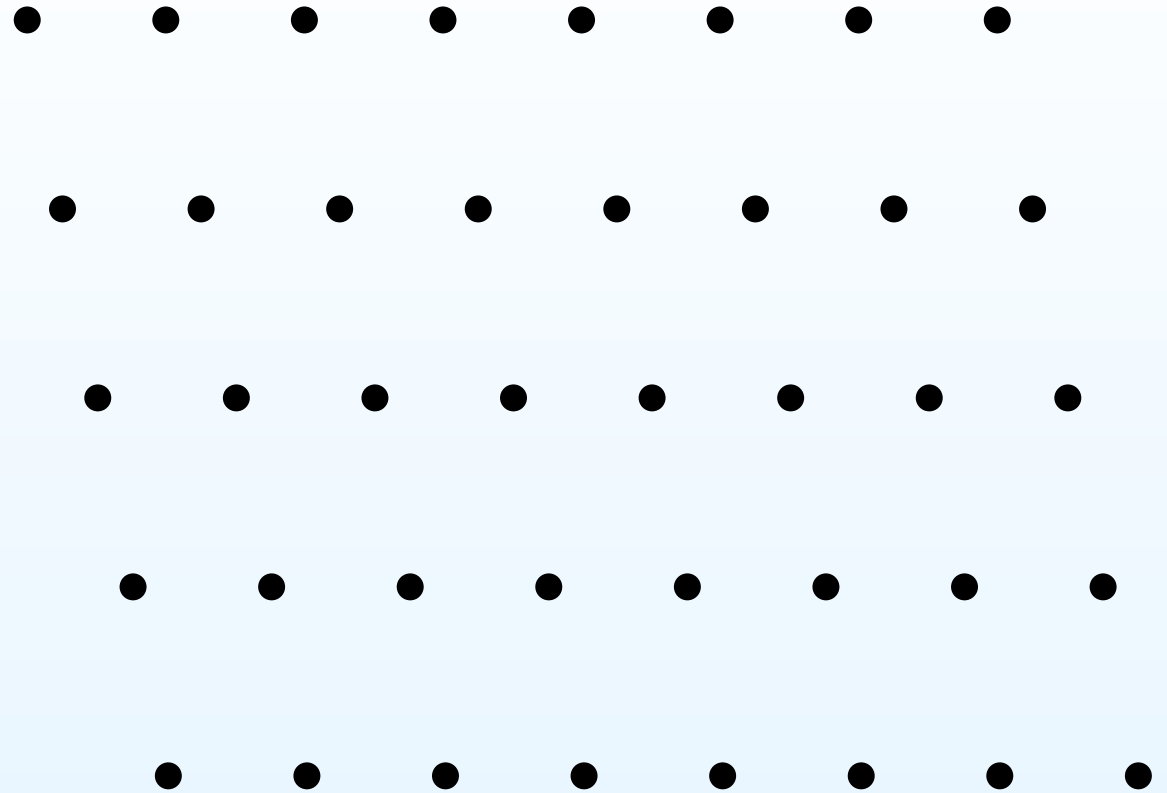

Instead of a single lattice consider a family of all lattices. We can continuously deform a lattice.

If we are interested only by the straight lines (geodesics) on the corresponding flat tori, we do not distinguish lattices which differ by a rotation or a homothety.

Space of lattices

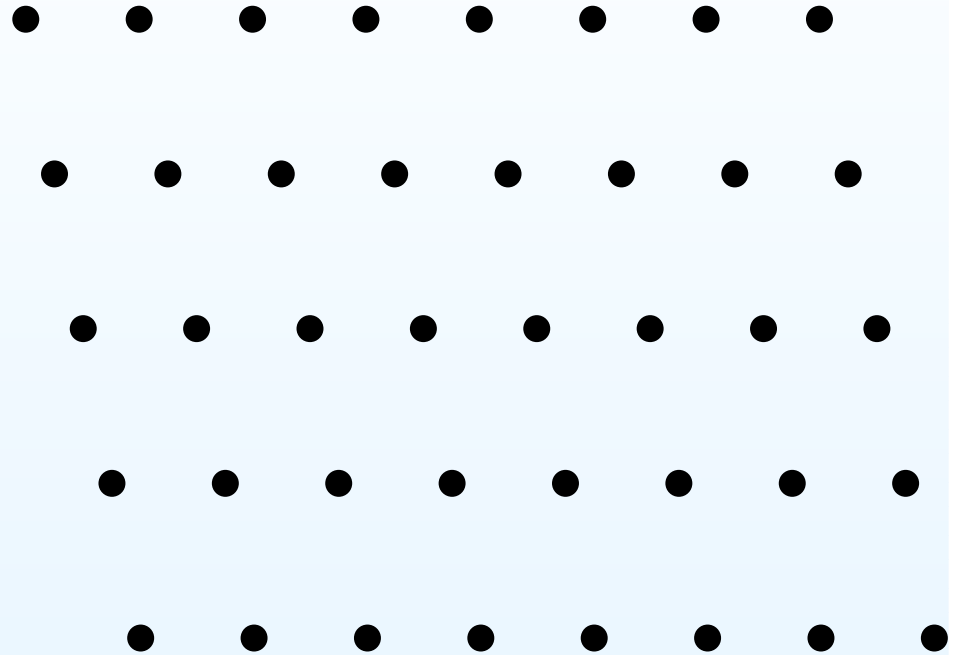

If we are interested only by the straight lines (geodesics) on the corresponding flat tori, we do not distinguish lattices which differ by a rotation or a homothety.

Space of lattices: fundamental domain

- Choosing an appropriate homothety and rotation we can place the shortest vector of the lattice to the horizontal unit vector.

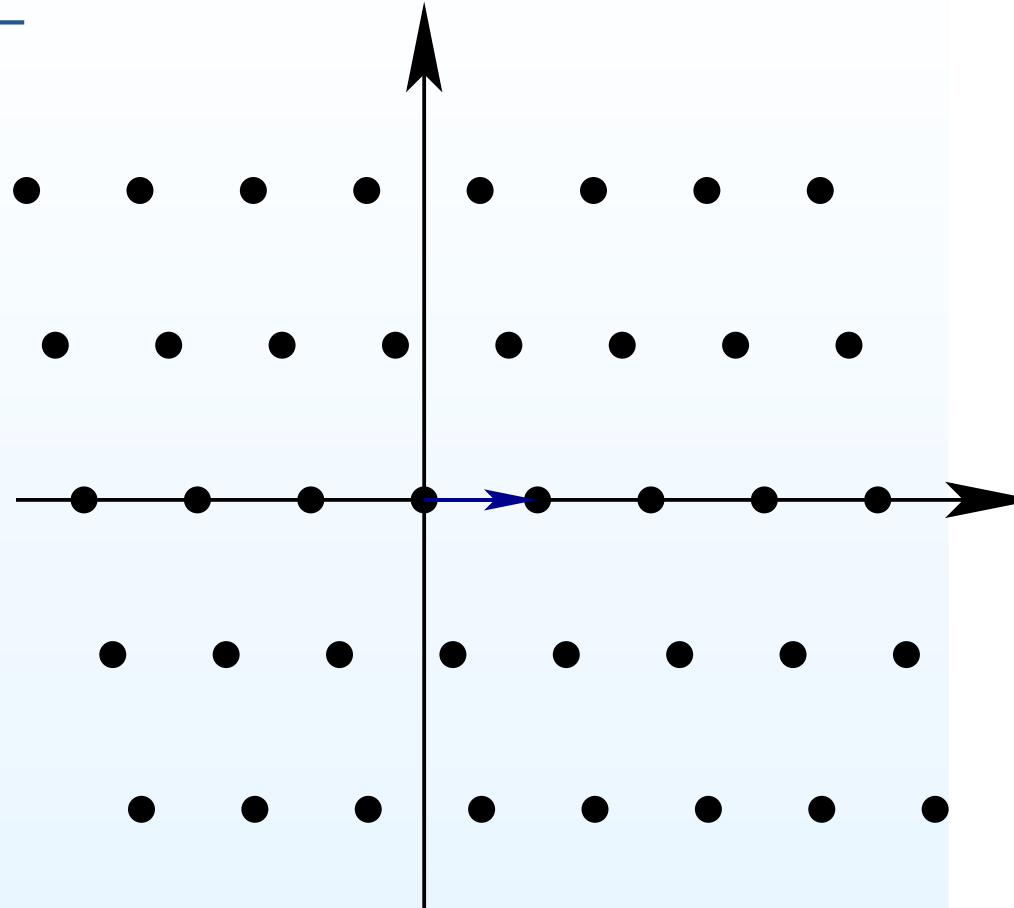

Space of lattices: fundamental domain

- Choosing an appropriate homothety and rotation we can place the shortest vector of the lattice to the horizontal unit vector.
- Consider the shortest vector of the lattice located in the upper half-plane.

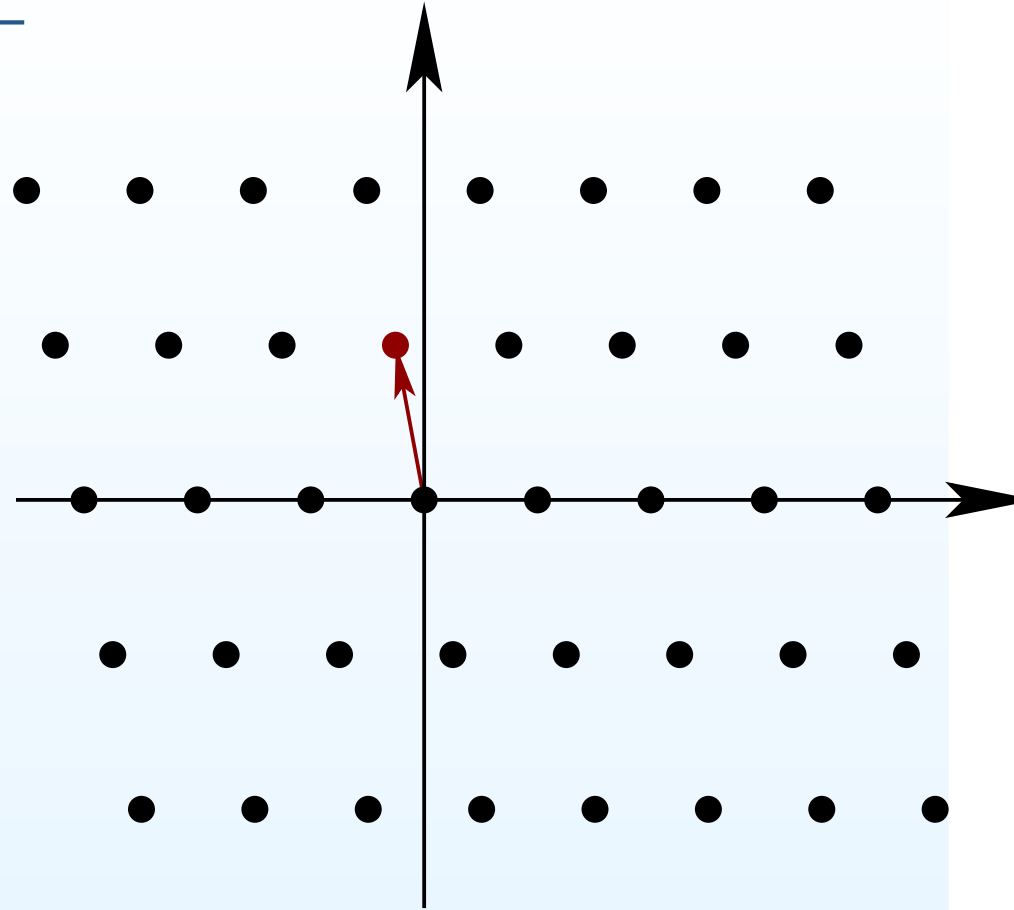

Space of lattices: fundamental domain

- Choosing an appropriate homothety and rotation we can place the shortest vector of the lattice to the horizontal unit vector.
- Consider the shortest vector of the lattice located in the upper half-plane.
- It lives outside the unit disc.

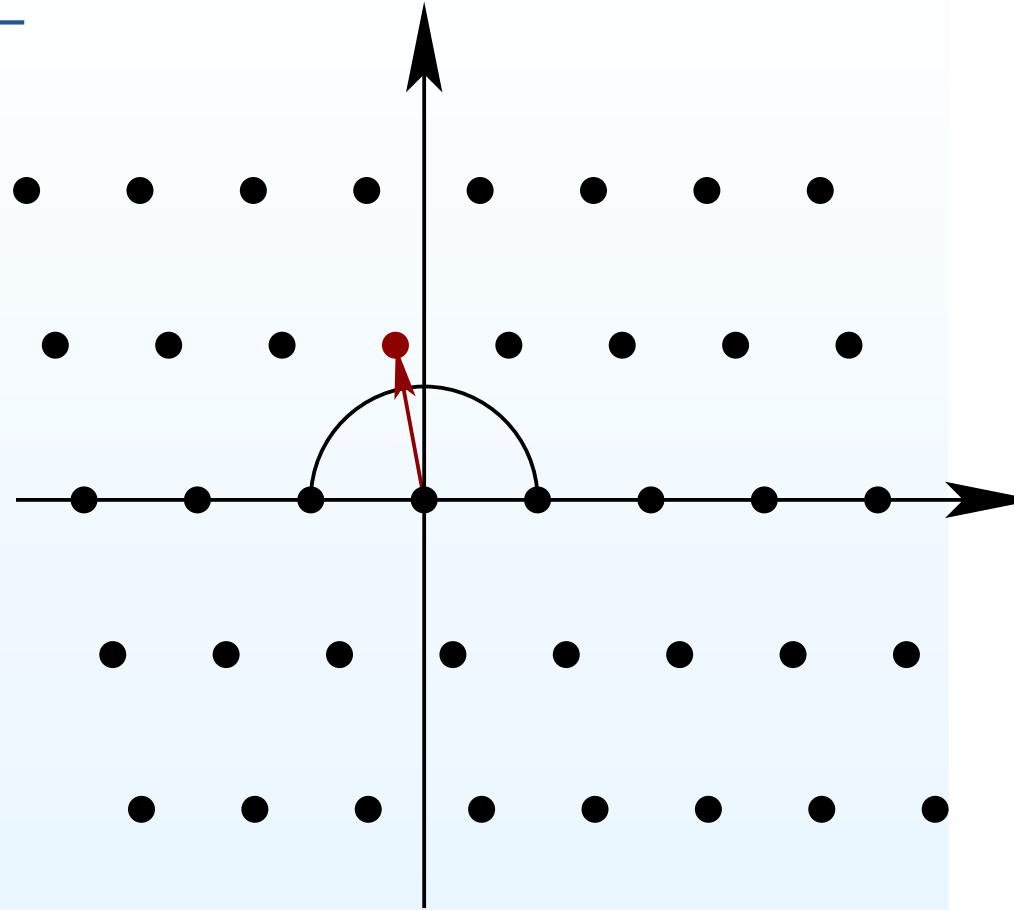

Space of lattices: fundamental domain

- Choosing an appropriate homothety and rotation we can place the shortest vector of the lattice to the horizontal unit vector.
- Consider the shortest vector of the lattice located in the upper half-plane.
- It lives outside the unit disc.
- It belongs to the strip $-1/2 \leq x \leq 1/2$.

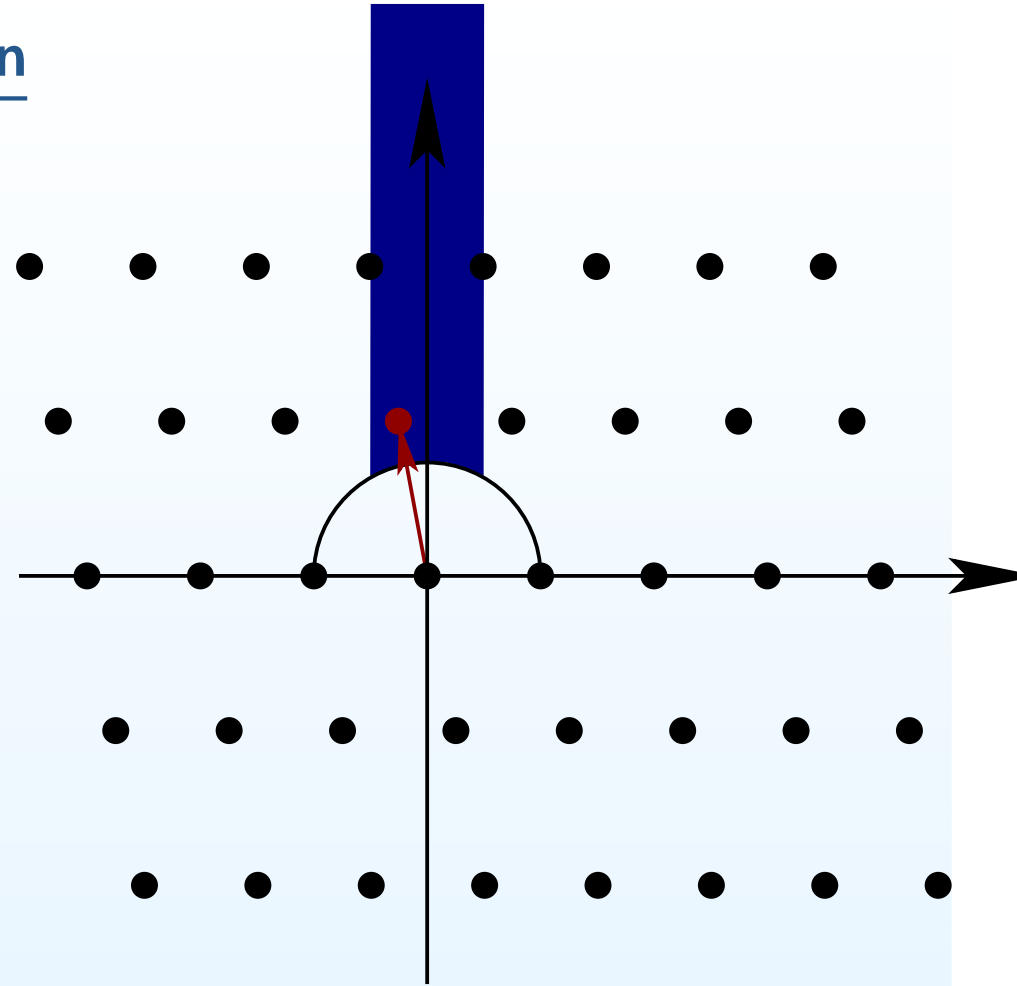

Space of lattices: fundamental domain

- Choosing an appropriate homothety and rotation we can place the shortest vector of the lattice to the horizontal unit vector.
- Consider the shortest vector of the lattice located in the upper half-plane.
- It lives outside the unit disc.
- It belongs to the strip $-1/2 \leq x \leq 1/2$.

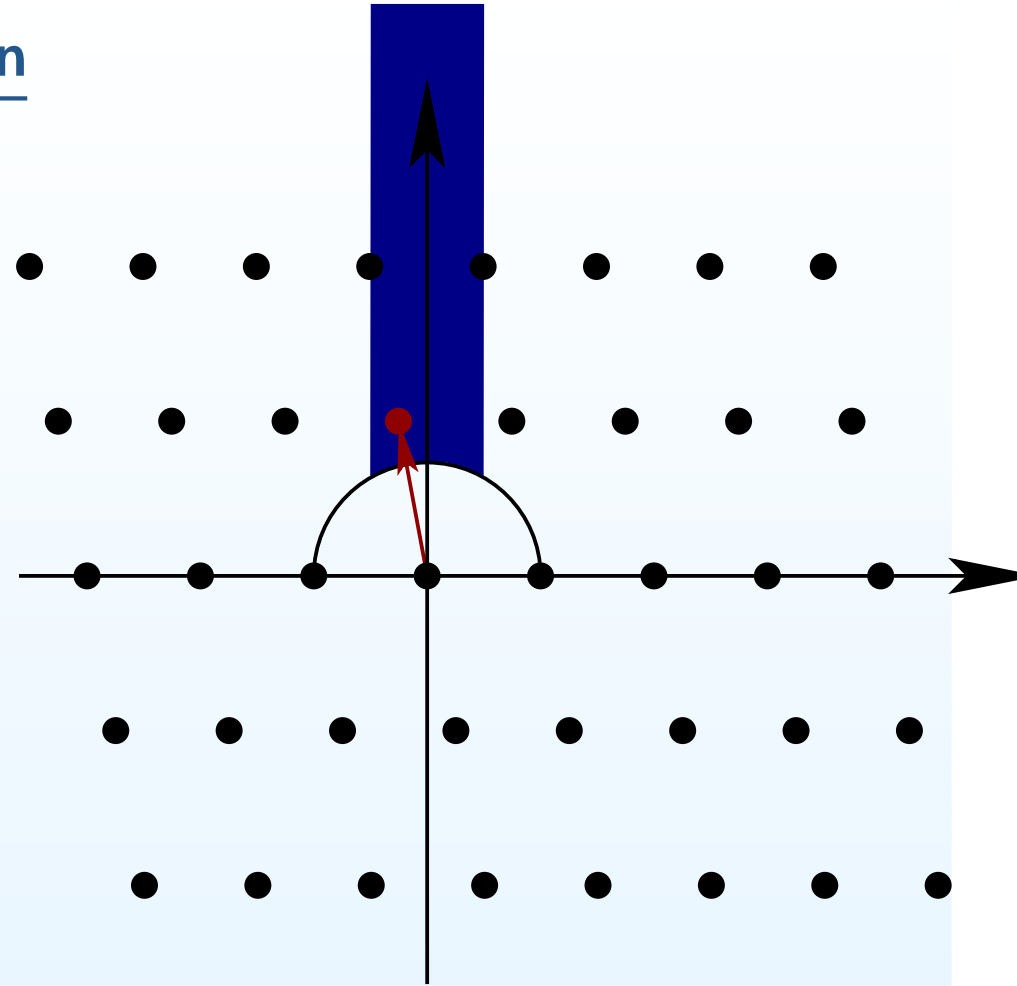

We have constructed a fundamental domain in the space of lattices.

Family of flat tori

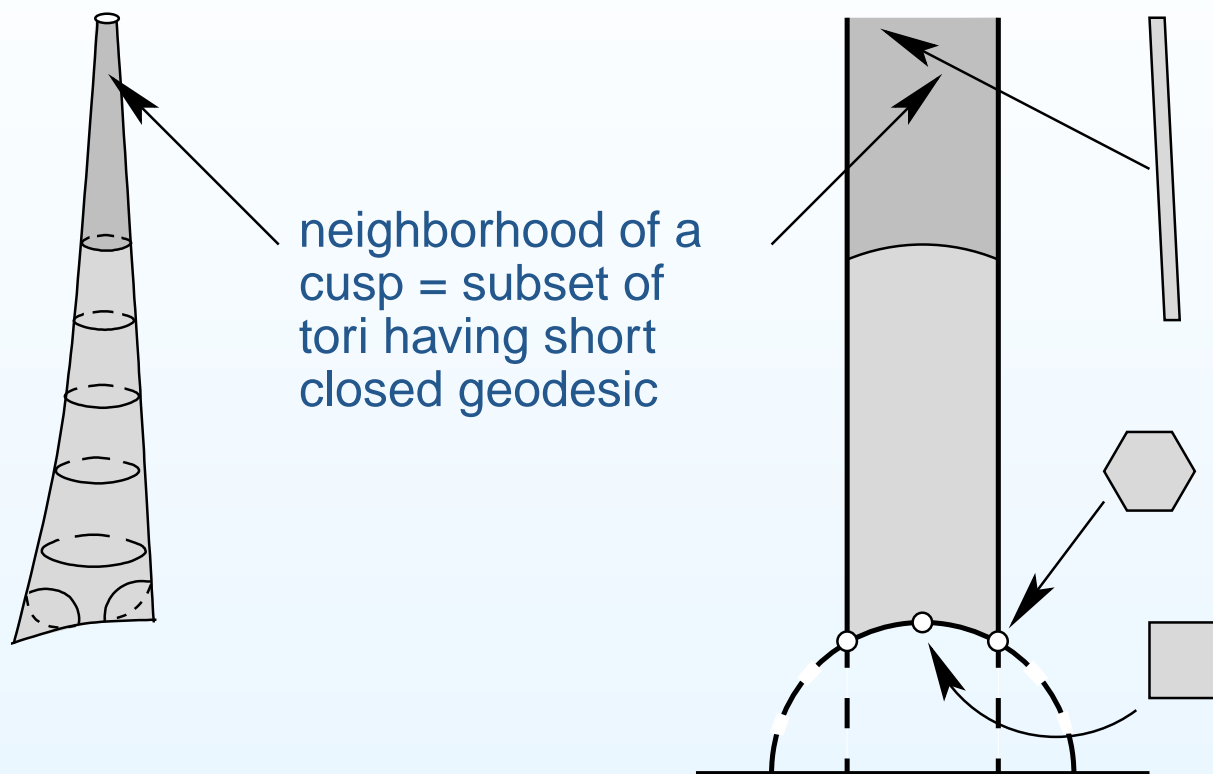

The corresponding “modular surface” is not compact: flat tori representing points, which are close to the cusp, are almost degenerate: they have a very short closed geodesic.

The modular surface inherits the hyperbolic metric from the upper half-plane.

Family of flat tori

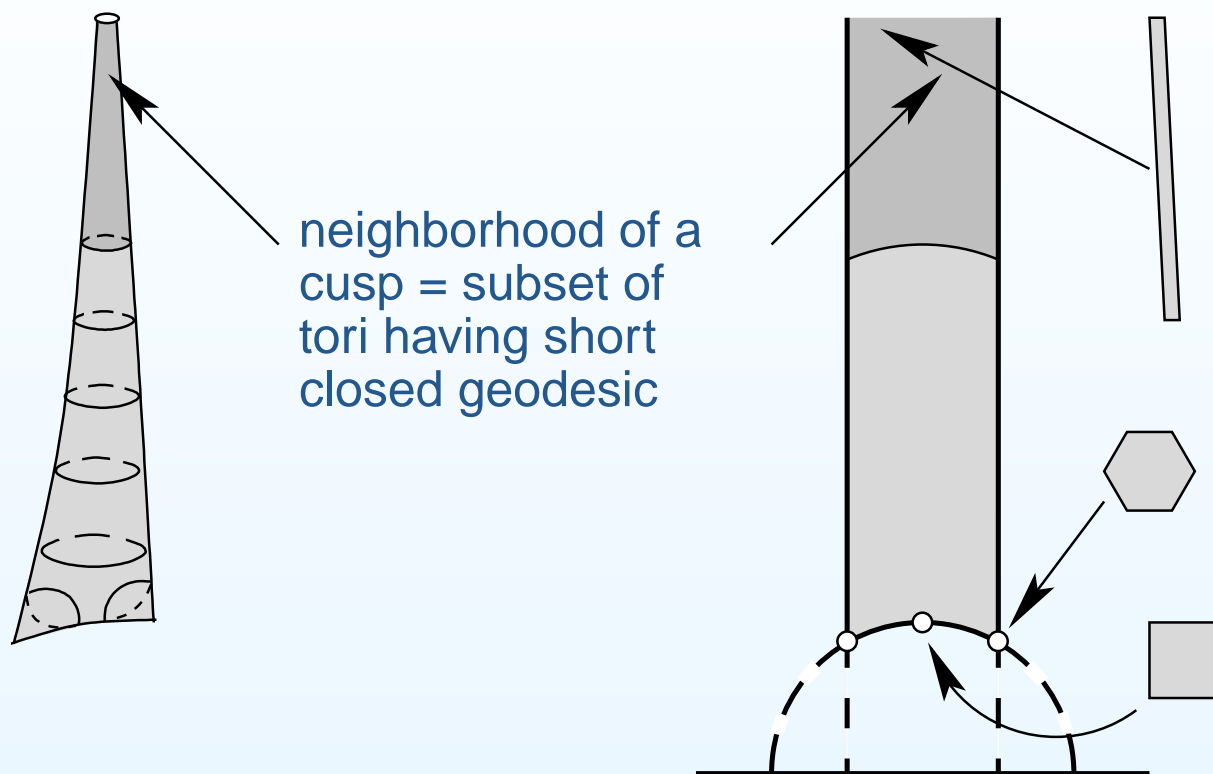

The corresponding “modular surface” is not compact: flat tori representing points, which are close to the cusp, are almost degenerate: they have a very short closed geodesic.

The modular surface inherits the hyperbolic metric from the upper half-plane.

Billiard in a polygon: artistic image



Varvara Stepanova. Joueurs de billard. Thyssen Museum, Madrid