

Dynamics and Geometry of Moduli Spaces

Lecture 6. Mirzakhani's count of simple closed geodesics

Anton Zorich
University Paris Cité

March 28, 2023



Hyperbolic geometry of surfaces

- Hyperbolic surfaces
- Simple closed geodesics
- Topological types of simple closed curves
- Mapping class group
- Exercise: separating curves
- Families of hyperbolic surfaces
- Moduli space

$\mathcal{M}_{g,n}$

Multicurves

Mirzakhani's count

Average number of simple closed geodesics

Hyperbolic geometry of surfaces

Hyperbolic surfaces

Any smooth orientable surface of genus $g \geq 2$ admits a metric of constant negative curvature (usually chosen to be -1), called *hyperbolic* metric.

Allowing the metric to have several singularities (cusps), one can construct a hyperbolic metric also on a sphere and on a torus.

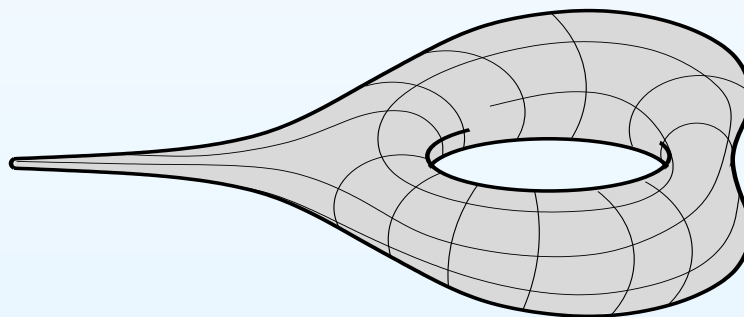
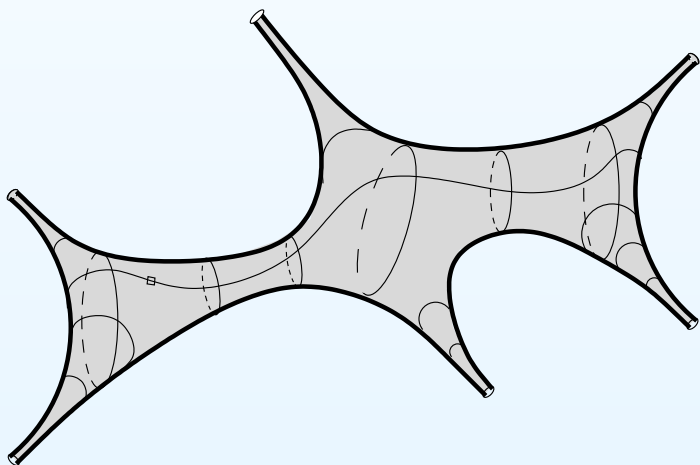

Simple closed curves and simple closed geodesics

A smooth closed curve on a surface is called *simple* if it does not have self-intersections.

Suppose that we have a simple closed curve γ on a *hyperbolic surface* (possibly with cusps). Suppose that the curve is *essential*, that is not contractible to a small curve encircling some disc or some cusp.

Interpreting our curve as an elastic loop, let it slide along the surface to contract to the shortest shape in our hyperbolic metric. We get a closed geodesic, which remains to be smooth non self-intersecting curve.

Simple closed curves and simple closed geodesics

A smooth closed curve on a surface is called *simple* if it does not have self-intersections.

Suppose that we have a simple closed curve γ on a *hyperbolic surface* (possibly with cusps). Suppose that the curve is *essential*, that is not contractible to a small curve encircling some disc or some cusp.

Interpreting our curve as an elastic loop, let it slide along the surface to contract to the shortest shape in our hyperbolic metric. We get a closed geodesic, which remains to be smooth non self-intersecting curve.

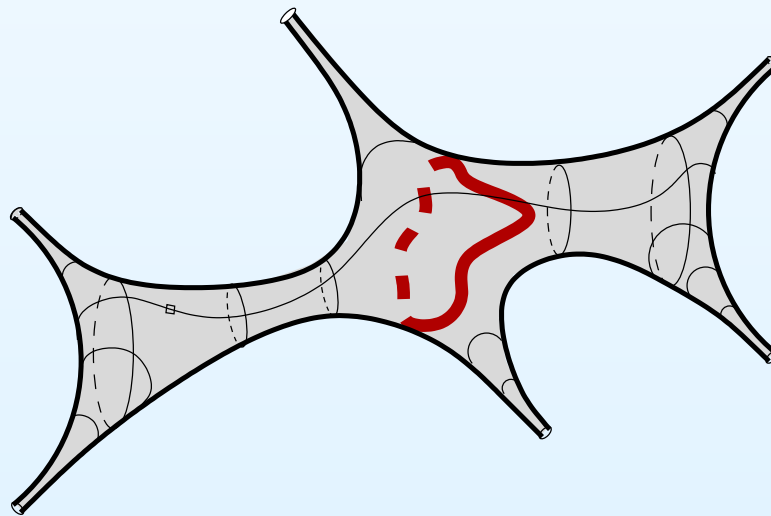

Simple closed curves and simple closed geodesics

A smooth closed curve on a surface is called *simple* if it does not have self-intersections.

Suppose that we have a simple closed curve γ on a *hyperbolic surface* (possibly with cusps). Suppose that the curve is *essential*, that is not contractible to a small curve encircling some disc or some cusp.

Interpreting our curve as an elastic loop, let it slide along the surface to contract to the shortest shape in our hyperbolic metric. We get a closed geodesic, which remains to be smooth non self-intersecting curve.

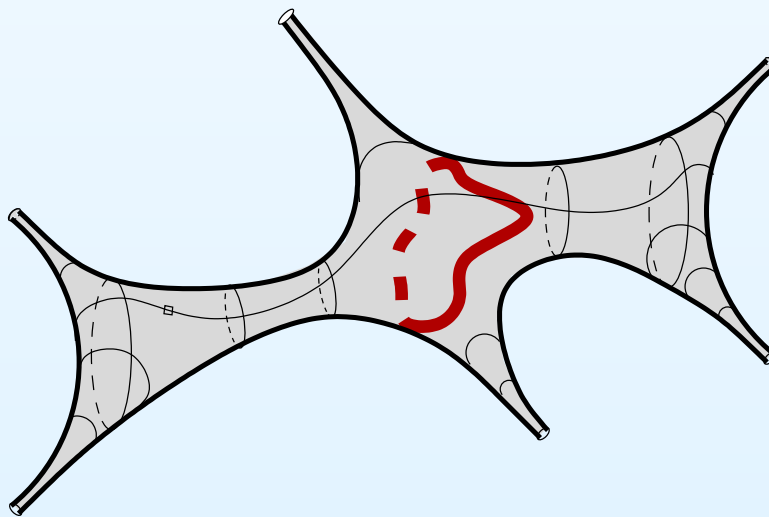

Simple closed curves and simple closed geodesics

A smooth closed curve on a surface is called *simple* if it does not have self-intersections.

Suppose that we have a simple closed curve γ on a *hyperbolic surface* (possibly with cusps). Suppose that the curve is *essential*, that is not contractible to a small curve encircling some disc or some cusp.

Interpreting our curve as an elastic loop, let it slide along the surface to contract to the shortest shape in our hyperbolic metric. We get a closed geodesic, which remains to be smooth non self-intersecting curve.

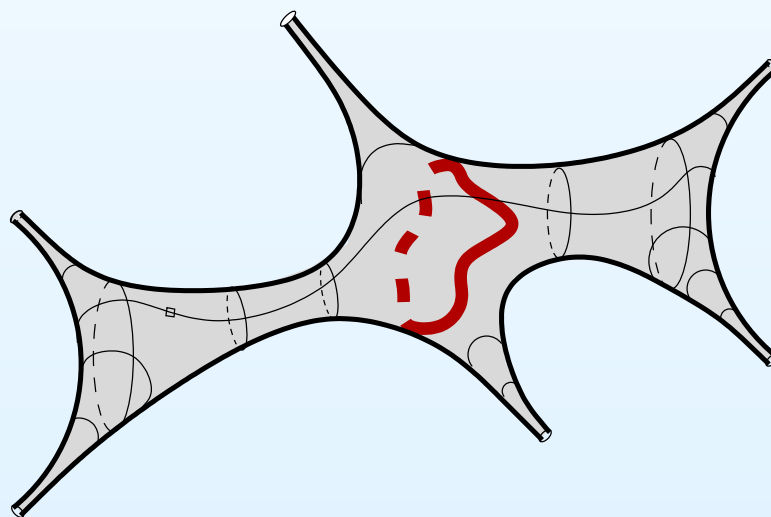

Simple closed curves and simple closed geodesics

A smooth closed curve on a surface is called *simple* if it does not have self-intersections.

Suppose that we have a simple closed curve γ on a *hyperbolic surface* (possibly with cusps). Suppose that the curve is *essential*, that is not contractible to a small curve encircling some disc or some cusp.

Interpreting our curve as an elastic loop, let it slide along the surface to contract to the shortest shape in our hyperbolic metric. We get a closed geodesic, which remains to be smooth non self-intersecting curve.

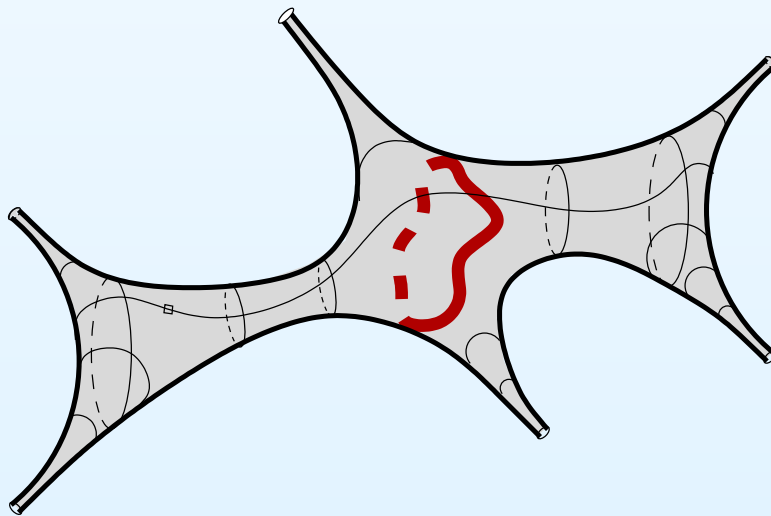

Simple closed curves and simple closed geodesics

A smooth closed curve on a surface is called *simple* if it does not have self-intersections.

Suppose that we have a simple closed curve γ on a *hyperbolic surface* (possibly with cusps). Suppose that the curve is *essential*, that is not contractible to a small curve encircling some disc or some cusp.

Interpreting our curve as an elastic loop, let it slide along the surface to contract to the shortest shape in our hyperbolic metric. We get a closed geodesic, which remains to be smooth non self-intersecting curve.

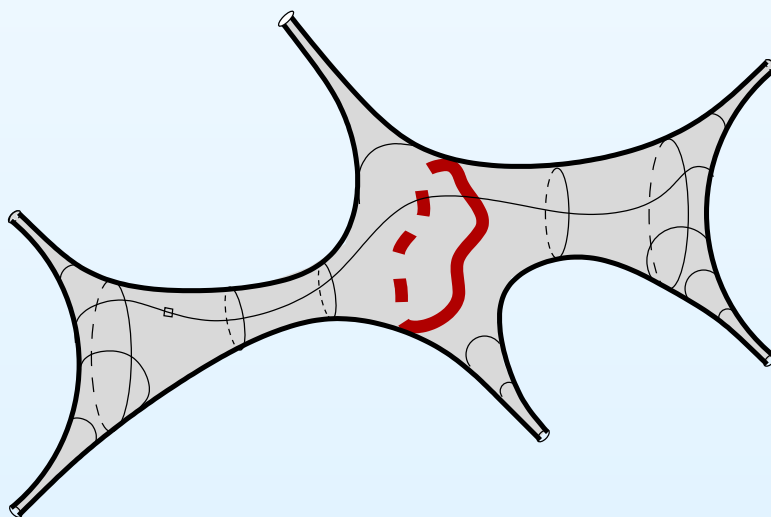

Simple closed curves and simple closed geodesics

A smooth closed curve on a surface is called *simple* if it does not have self-intersections.

Suppose that we have a simple closed curve γ on a *hyperbolic surface* (possibly with cusps). Suppose that the curve is *essential*, that is not contractible to a small curve encircling some disc or some cusp.

Interpreting our curve as an elastic loop, let it slide along the surface to contract to the shortest shape in our hyperbolic metric. We get a closed geodesic, which remains to be smooth non self-intersecting curve.

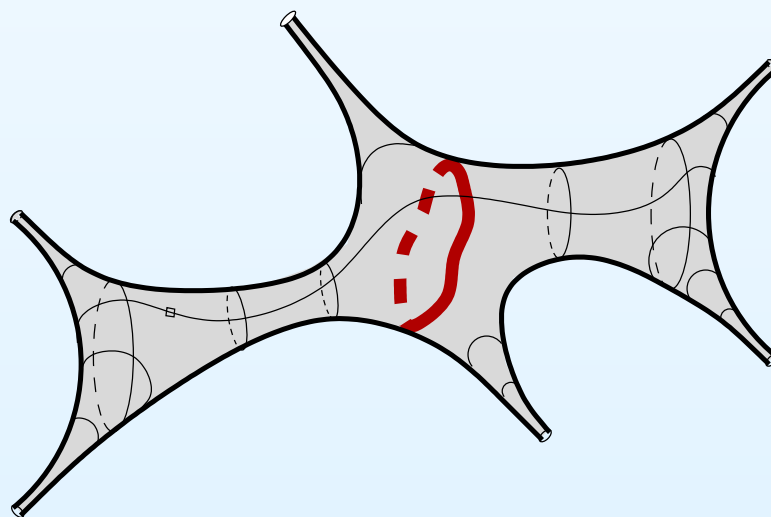

Simple closed curves and simple closed geodesics

A smooth closed curve on a surface is called *simple* if it does not have self-intersections.

Suppose that we have a simple closed curve γ on a *hyperbolic surface* (possibly with cusps). Suppose that the curve is *essential*, that is not contractible to a small curve encircling some disc or some cusp.

Interpreting our curve as an elastic loop, let it slide along the surface to contract to the shortest shape in our hyperbolic metric. We get a closed geodesic, which remains to be smooth non self-intersecting curve.

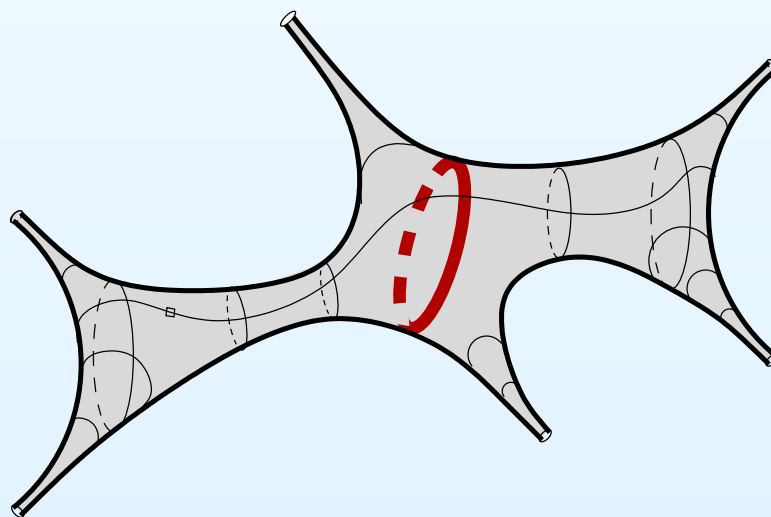

Simple closed curves and simple closed geodesics

Fact. *For any hyperbolic metric and any essential simple closed curve on a surface, there exists a unique geodesic representative in the free homotopy class of the curve; it is realized by a simple closed geodesic.*

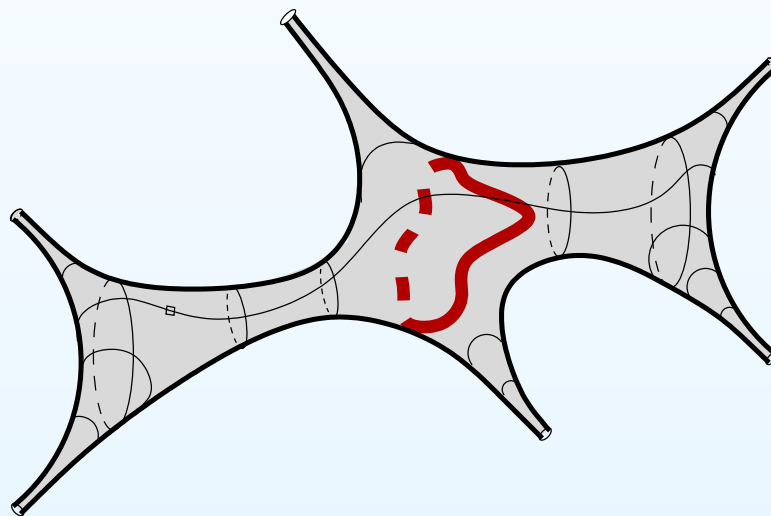

Speaking of a “free homotopy class” we puncture the surface at all cusps so that curves do not traverse cusps along continuous deformations.

Simple closed curves and simple closed geodesics

Fact. *For any hyperbolic metric and any essential simple closed curve on a surface, there exists a unique geodesic representative in the free homotopy class of the curve; it is realized by a simple closed geodesic.*

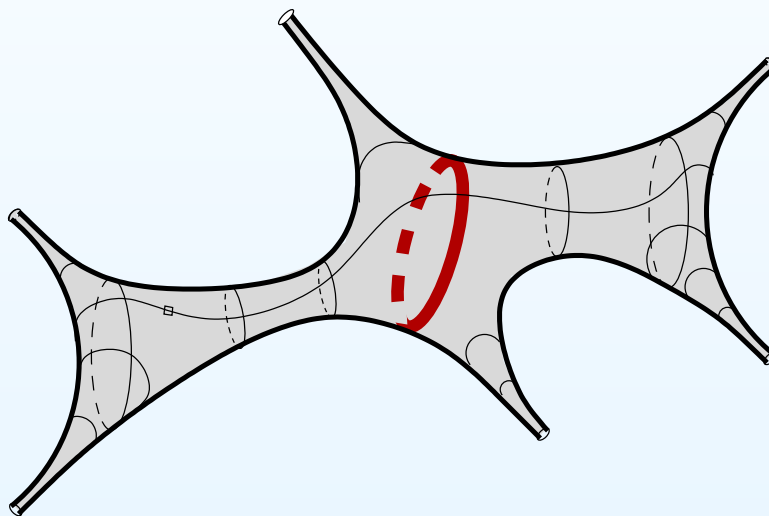

Speaking of a “free homotopy class” we puncture the surface at all cusps so that curves do not traverse cusps along continuous deformations.

Topological types of simple closed curves

Let us say that two simple closed curves on a smooth surface have the same *topological type* if there is a diffeomorphism of the surface sending one curve to another.

It immediately follows from the classification theorem of surfaces that there is a finite number of topological types of simple closed curves. For example, if the surface does not have punctures, all simple closed curves which do not separate the surface into two pieces, belong to the same class.

Indeed: the classification theorem implies that cutting the surface open along such two simple closed curves we get two diffeomorphic surfaces with two boundary components. A little extra effort allows to build a diffeomorphism of the initial closed surface to itself sending the first curve to the second.

Topological types of simple closed curves

Let us say that two simple closed curves on a smooth surface have the same *topological type* if there is a diffeomorphism of the surface sending one curve to another.

It immediately follows from the classification theorem of surfaces that there is a finite number of topological types of simple closed curves. For example, if the surface does not have punctures, all simple closed curves which do not separate the surface into two pieces, belong to the same class.

Indeed: the classification theorem implies that cutting the surface open along such two simple closed curves we get two diffeomorphic surfaces with two boundary components. A little extra effort allows to build a diffeomorphism of the initial closed surface to itself sending the first curve to the second.

Topological types of simple closed curves

Let us say that two simple closed curves on a smooth surface have the same *topological type* if there is a diffeomorphism of the surface sending one curve to another.

It immediately follows from the classification theorem of surfaces that there is a finite number of topological types of simple closed curves. For example, if the surface does not have punctures, all simple closed curves which do not separate the surface into two pieces, belong to the same class.

Indeed: the classification theorem implies that cutting the surface open along such two simple closed curves we get two diffeomorphic surfaces with two boundary components. A little extra effort allows to build a diffeomorphism of the initial closed surface to itself sending the first curve to the second.

Mapping class group

The group of all diffeomorphisms of a closed smooth orientable surface of genus g quotient over diffeomorphisms homotopic to identity is called the *mapping class group* and is denoted by Mod_g .

When the surface has n marked points (punctures) we require that diffeomorphism sends marked points to marked points; the corresponding mapping class group is denoted $\text{Mod}_{g,n}$.

Mapping class group

The group of all diffeomorphisms of a closed smooth orientable surface of genus g quotient over diffeomorphisms homotopic to identity is called the *mapping class group* and is denoted by Mod_g .

When the surface has n marked points (punctures) we require that diffeomorphism sends marked points to marked points; the corresponding mapping class group is denoted $\text{Mod}_{g,n}$.

Exercise: separating curves

Exercise. *Prove that all curves presented at the picture are separating.*

Hint: choose an appropriate basis of cycles and verify that intersection numbers of each curve with all basic cycles are zero.

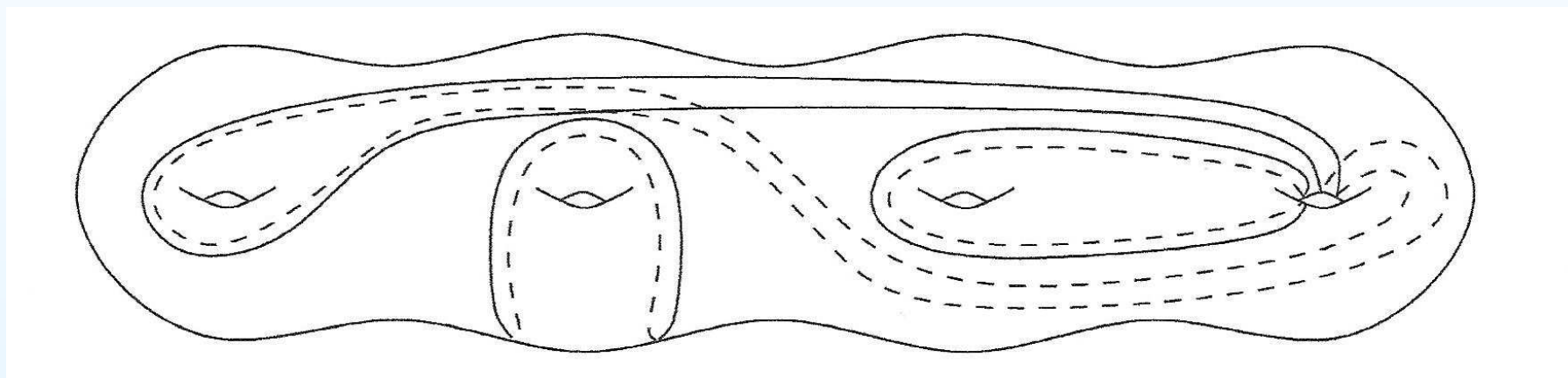

The picture is taken from the book of B. Farb and D. Margalit “A Primer on Mapping Class Groups”.

Exercise. *Detect which curves are essential and which essential curves belong to the same orbit of the mapping class group.*

Exercise: orbits of the mapping class group

Select all simple closed curves in the picture below which might be isotopic to simple closed hyperbolic geodesics on a twice-punctured surface of genus two.

How many distinct orbits of $\text{Mod}_{2,2}$ they represent? Indicate which curves correspond to which orbit.

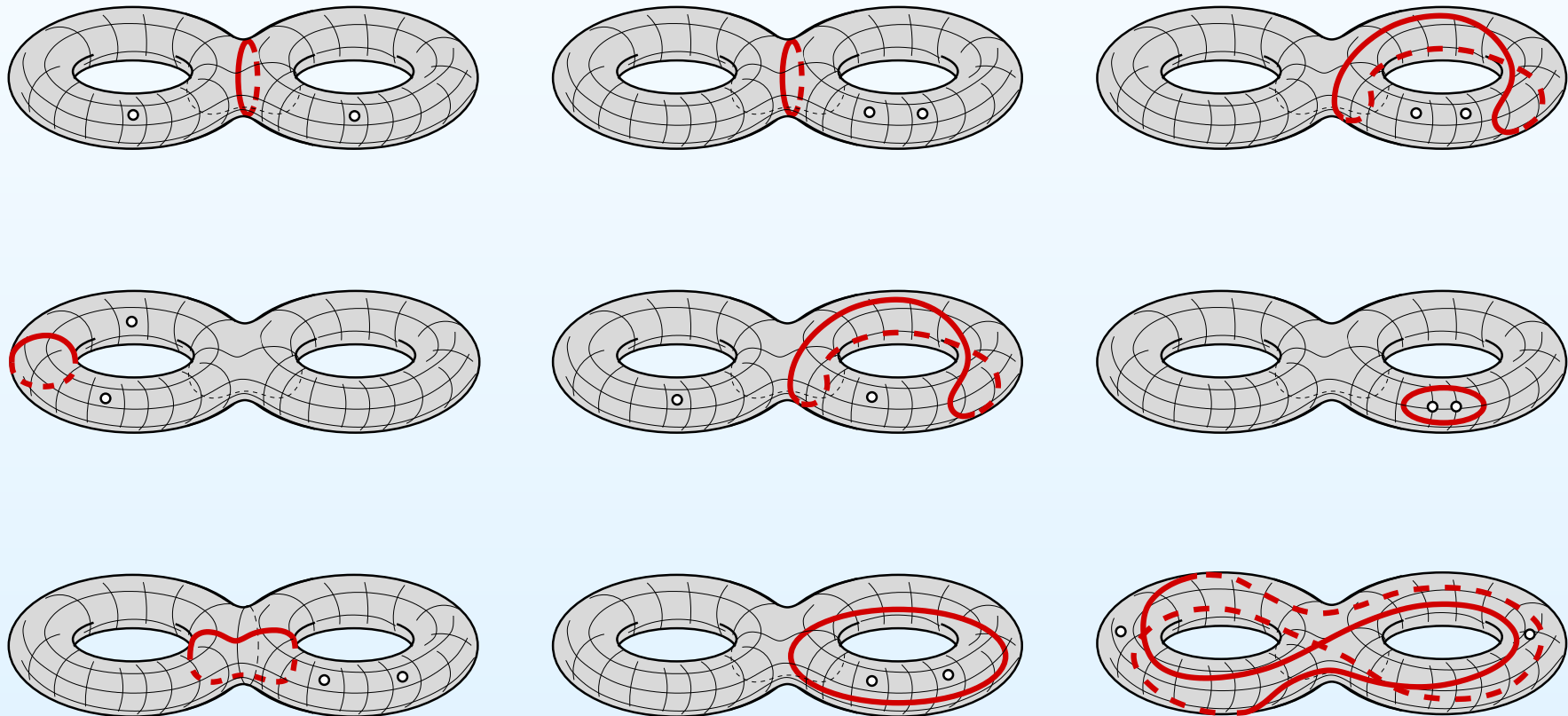

Families of hyperbolic surfaces

Consider a configuration of four distinct points on the Riemann sphere $\mathbb{C}P^1$. Using appropriate holomorphic automorphism of $\mathbb{C}P^1$ we can send three out of four points to 0 , 1 and ∞ . There is no more freedom: any further holomorphic automorphism of $\mathbb{C}P^1$ fixing 0 , 1 and ∞ is already the identity transformation. The remaining point serves as a complex parameter in the space $\mathcal{M}_{0,4}$ of configurations of four distinct points on $\mathbb{C}P^1$ (up to a holomorphic diffeomorphism).

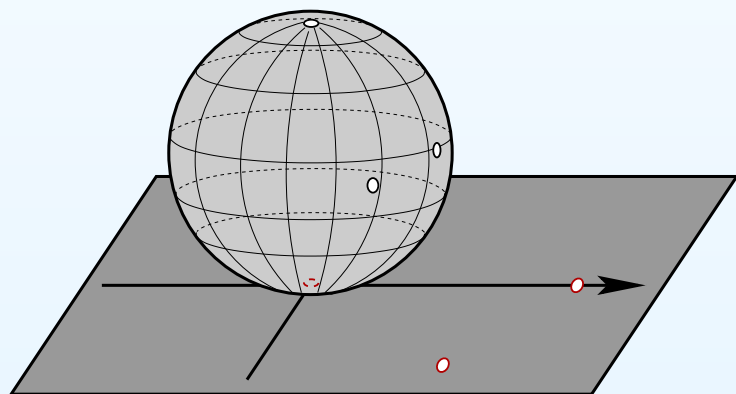

Families of hyperbolic surfaces

Consider a configuration of four distinct points on the Riemann sphere $\mathbb{C}P^1$. Using appropriate holomorphic automorphism of $\mathbb{C}P^1$ we can send three out of four points to 0 , 1 and ∞ . There is no more freedom: any further holomorphic automorphism of $\mathbb{C}P^1$ fixing 0 , 1 and ∞ is already the identity transformation. The remaining point serves as a complex parameter in the space $\mathcal{M}_{0,4}$ of configurations of four distinct points on $\mathbb{C}P^1$ (up to a holomorphic diffeomorphism).

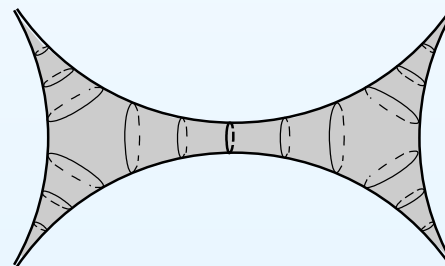
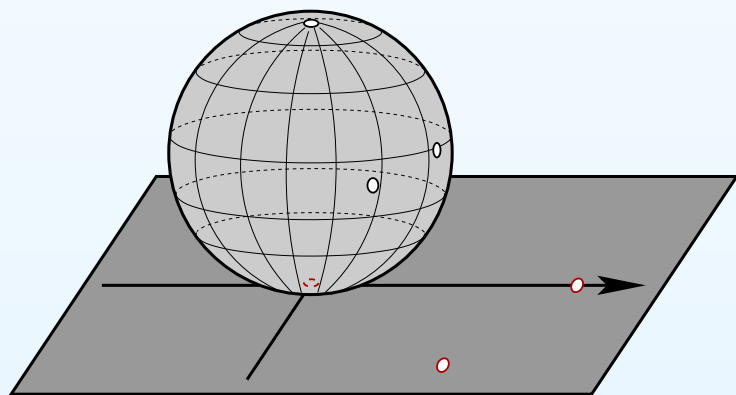

By the uniformization theorem, complex structures on a surface with marked points are in natural bijection with hyperbolic metrics of curvature -1 with cusps at the marked points, so the *moduli space* $\mathcal{M}_{0,4}$ can be also seen as the family of hyperbolic spheres with four cusps. Deforming the configuration of points we change the shape of the corresponding hyperbolic surface.

Families of hyperbolic surfaces

Consider a configuration of four distinct points on the Riemann sphere $\mathbb{C}P^1$. Using appropriate holomorphic automorphism of $\mathbb{C}P^1$ we can send three out of four points to 0 , 1 and ∞ . There is no more freedom: any further holomorphic automorphism of $\mathbb{C}P^1$ fixing 0 , 1 and ∞ is already the identity transformation. The remaining point serves as a complex parameter in the space $\mathcal{M}_{0,4}$ of configurations of four distinct points on $\mathbb{C}P^1$ (up to a holomorphic diffeomorphism).

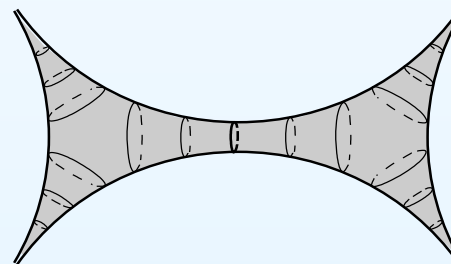
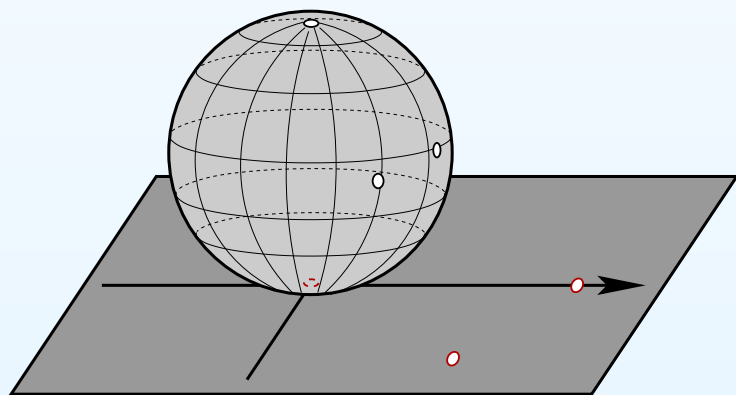

By the uniformization theorem, complex structures on a surface with marked points are in natural bijection with hyperbolic metrics of curvature -1 with cusps at the marked points, so the *moduli space* $\mathcal{M}_{0,4}$ can be also seen as the family of hyperbolic spheres with four cusps. Deforming the configuration of points we change the shape of the corresponding hyperbolic surface.

Families of hyperbolic surfaces

Consider a configuration of four distinct points on the Riemann sphere $\mathbb{C}P^1$. Using appropriate holomorphic automorphism of $\mathbb{C}P^1$ we can send three out of four points to 0 , 1 and ∞ . There is no more freedom: any further holomorphic automorphism of $\mathbb{C}P^1$ fixing 0 , 1 and ∞ is already the identity transformation. The remaining point serves as a complex parameter in the space $\mathcal{M}_{0,4}$ of configurations of four distinct points on $\mathbb{C}P^1$ (up to a holomorphic diffeomorphism).

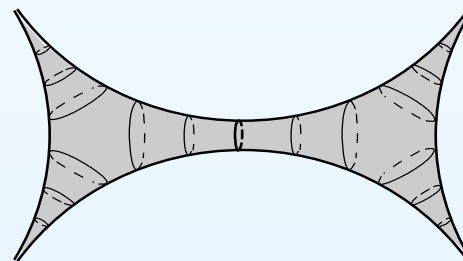
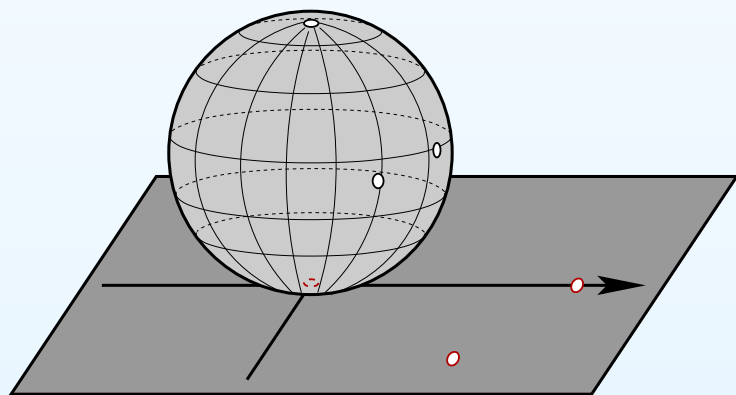

By the uniformization theorem, complex structures on a surface with marked points are in natural bijection with hyperbolic metrics of curvature -1 with cusps at the marked points, so the *moduli space* $\mathcal{M}_{0,4}$ can be also seen as the family of hyperbolic spheres with four cusps. Deforming the configuration of points we change the shape of the corresponding hyperbolic surface.

Families of hyperbolic surfaces

Consider a configuration of four distinct points on the Riemann sphere $\mathbb{C}P^1$. Using appropriate holomorphic automorphism of $\mathbb{C}P^1$ we can send three out of four points to 0 , 1 and ∞ . There is no more freedom: any further holomorphic automorphism of $\mathbb{C}P^1$ fixing 0 , 1 and ∞ is already the identity transformation. The remaining point serves as a complex parameter in the space $\mathcal{M}_{0,4}$ of configurations of four distinct points on $\mathbb{C}P^1$ (up to a holomorphic diffeomorphism).

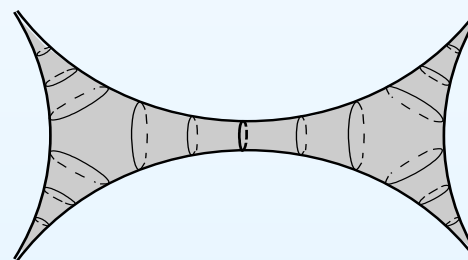
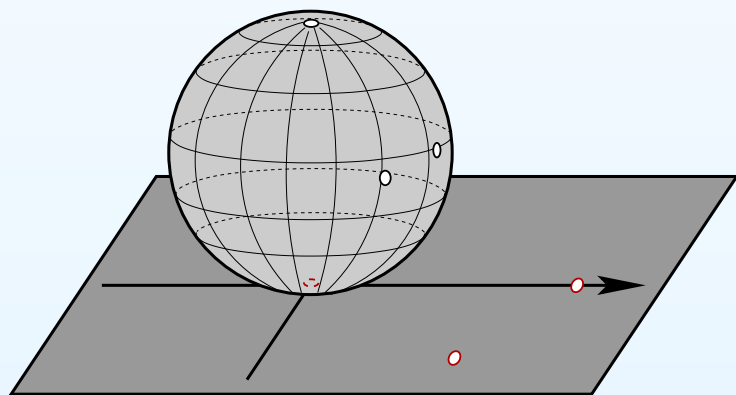

By the uniformization theorem, complex structures on a surface with marked points are in natural bijection with hyperbolic metrics of curvature -1 with cusps at the marked points, so the *moduli space* $\mathcal{M}_{0,4}$ can be also seen as the family of hyperbolic spheres with four cusps. Deforming the configuration of points we change the shape of the corresponding hyperbolic surface.

Families of hyperbolic surfaces

Consider a configuration of four distinct points on the Riemann sphere $\mathbb{C}P^1$. Using appropriate holomorphic automorphism of $\mathbb{C}P^1$ we can send three out of four points to 0 , 1 and ∞ . There is no more freedom: any further holomorphic automorphism of $\mathbb{C}P^1$ fixing 0 , 1 and ∞ is already the identity transformation. The remaining point serves as a complex parameter in the space $\mathcal{M}_{0,4}$ of configurations of four distinct points on $\mathbb{C}P^1$ (up to a holomorphic diffeomorphism).

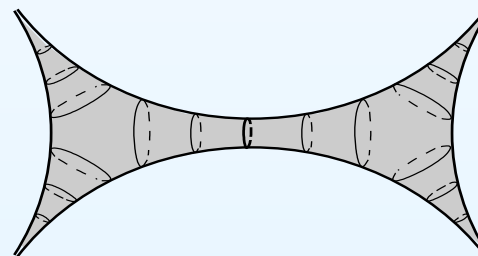
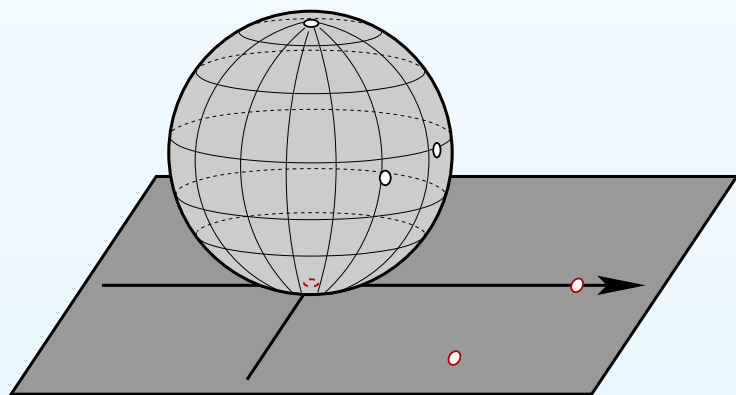

By the uniformization theorem, complex structures on a surface with marked points are in natural bijection with hyperbolic metrics of curvature -1 with cusps at the marked points, so the *moduli space* $\mathcal{M}_{0,4}$ can be also seen as the family of hyperbolic spheres with four cusps. Deforming the configuration of points we change the shape of the corresponding hyperbolic surface.

Families of hyperbolic surfaces

Consider a configuration of four distinct points on the Riemann sphere $\mathbb{C}P^1$. Using appropriate holomorphic automorphism of $\mathbb{C}P^1$ we can send three out of four points to 0 , 1 and ∞ . There is no more freedom: any further holomorphic automorphism of $\mathbb{C}P^1$ fixing 0 , 1 and ∞ is already the identity transformation. The remaining point serves as a complex parameter in the space $\mathcal{M}_{0,4}$ of configurations of four distinct points on $\mathbb{C}P^1$ (up to a holomorphic diffeomorphism).

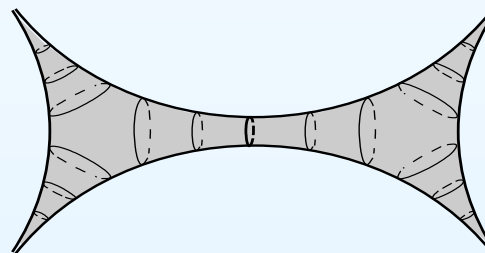
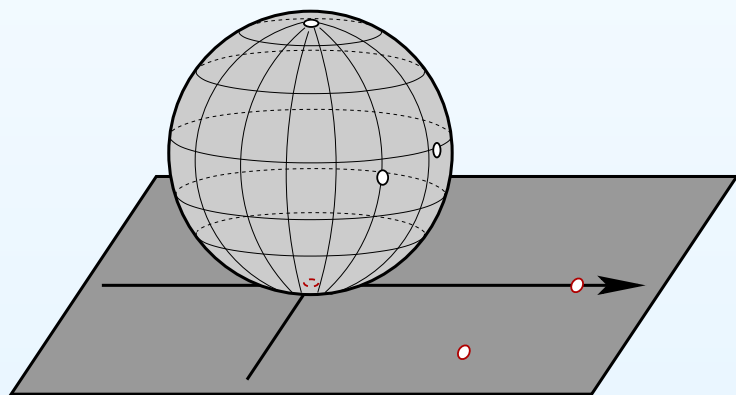

By the uniformization theorem, complex structures on a surface with marked points are in natural bijection with hyperbolic metrics of curvature -1 with cusps at the marked points, so the *moduli space* $\mathcal{M}_{0,4}$ can be also seen as the family of hyperbolic spheres with four cusps. Deforming the configuration of points we change the shape of the corresponding hyperbolic surface.

Families of hyperbolic surfaces

Consider a configuration of four distinct points on the Riemann sphere $\mathbb{C}P^1$. Using appropriate holomorphic automorphism of $\mathbb{C}P^1$ we can send three out of four points to 0 , 1 and ∞ . There is no more freedom: any further holomorphic automorphism of $\mathbb{C}P^1$ fixing 0 , 1 and ∞ is already the identity transformation. The remaining point serves as a complex parameter in the space $\mathcal{M}_{0,4}$ of configurations of four distinct points on $\mathbb{C}P^1$ (up to a holomorphic diffeomorphism).

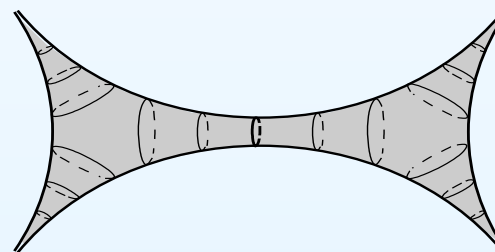
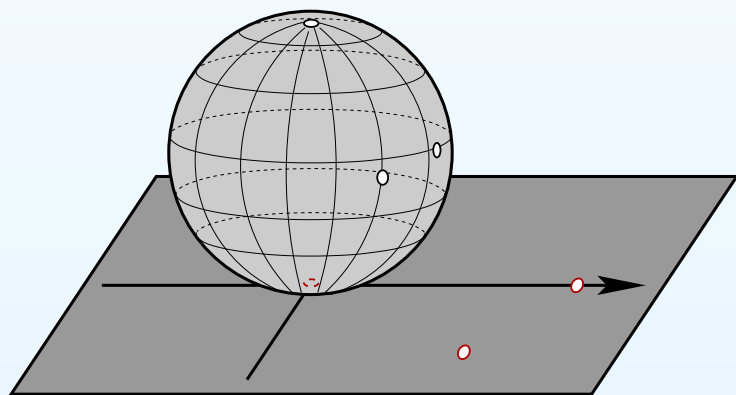

By the uniformization theorem, complex structures on a surface with marked points are in natural bijection with hyperbolic metrics of curvature -1 with cusps at the marked points, so the *moduli space* $\mathcal{M}_{0,4}$ can be also seen as the family of hyperbolic spheres with four cusps. Deforming the configuration of points we change the shape of the corresponding hyperbolic surface.

Families of hyperbolic surfaces

Consider a configuration of four distinct points on the Riemann sphere $\mathbb{C}P^1$. Using appropriate holomorphic automorphism of $\mathbb{C}P^1$ we can send three out of four points to 0 , 1 and ∞ . There is no more freedom: any further holomorphic automorphism of $\mathbb{C}P^1$ fixing 0 , 1 and ∞ is already the identity transformation. The remaining point serves as a complex parameter in the space $\mathcal{M}_{0,4}$ of configurations of four distinct points on $\mathbb{C}P^1$ (up to a holomorphic diffeomorphism).

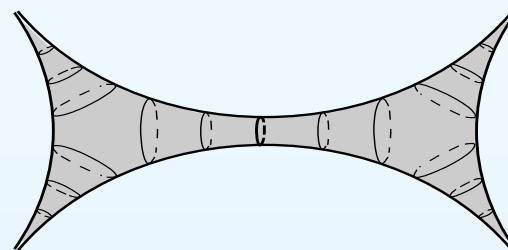
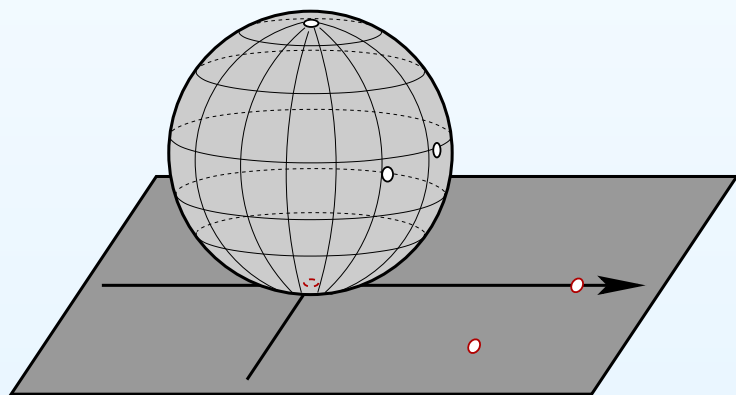

By the uniformization theorem, complex structures on a surface with marked points are in natural bijection with hyperbolic metrics of curvature -1 with cusps at the marked points, so the *moduli space* $\mathcal{M}_{0,4}$ can be also seen as the family of hyperbolic spheres with four cusps. Deforming the configuration of points we change the shape of the corresponding hyperbolic surface.

Families of hyperbolic surfaces

Consider a configuration of four distinct points on the Riemann sphere $\mathbb{C}P^1$. Using appropriate holomorphic automorphism of $\mathbb{C}P^1$ we can send three out of four points to 0 , 1 and ∞ . There is no more freedom: any further holomorphic automorphism of $\mathbb{C}P^1$ fixing 0 , 1 and ∞ is already the identity transformation. The remaining point serves as a complex parameter in the space $\mathcal{M}_{0,4}$ of configurations of four distinct points on $\mathbb{C}P^1$ (up to a holomorphic diffeomorphism).

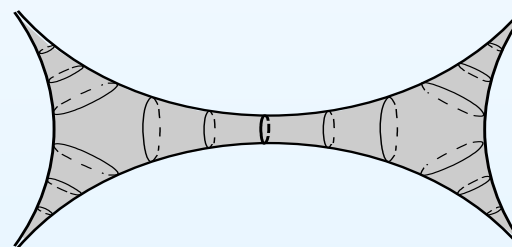
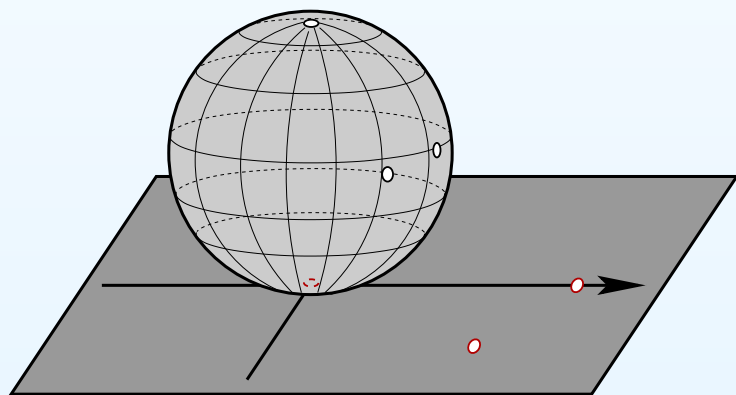

By the uniformization theorem, complex structures on a surface with marked points are in natural bijection with hyperbolic metrics of curvature -1 with cusps at the marked points, so the *moduli space* $\mathcal{M}_{0,4}$ can be also seen as the family of hyperbolic spheres with four cusps. Deforming the configuration of points we change the shape of the corresponding hyperbolic surface.

Families of hyperbolic surfaces

Consider a configuration of four distinct points on the Riemann sphere $\mathbb{C}P^1$. Using appropriate holomorphic automorphism of $\mathbb{C}P^1$ we can send three out of four points to 0 , 1 and ∞ . There is no more freedom: any further holomorphic automorphism of $\mathbb{C}P^1$ fixing 0 , 1 and ∞ is already the identity transformation. The remaining point serves as a complex parameter in the space $\mathcal{M}_{0,4}$ of configurations of four distinct points on $\mathbb{C}P^1$ (up to a holomorphic diffeomorphism).

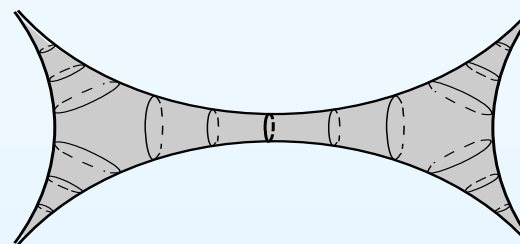
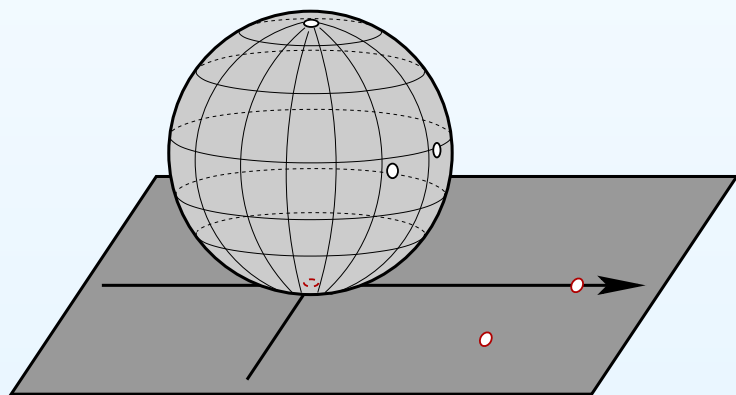

By the uniformization theorem, complex structures on a surface with marked points are in natural bijection with hyperbolic metrics of curvature -1 with cusps at the marked points, so the *moduli space* $\mathcal{M}_{0,4}$ can be also seen as the family of hyperbolic spheres with four cusps. Deforming the configuration of points we change the shape of the corresponding hyperbolic surface.

Families of hyperbolic surfaces

Consider a configuration of four distinct points on the Riemann sphere $\mathbb{C}P^1$. Using appropriate holomorphic automorphism of $\mathbb{C}P^1$ we can send three out of four points to 0 , 1 and ∞ . There is no more freedom: any further holomorphic automorphism of $\mathbb{C}P^1$ fixing 0 , 1 and ∞ is already the identity transformation. The remaining point serves as a complex parameter in the space $\mathcal{M}_{0,4}$ of configurations of four distinct points on $\mathbb{C}P^1$ (up to a holomorphic diffeomorphism).

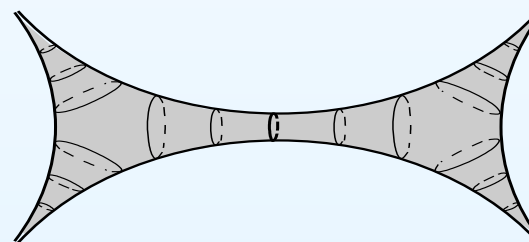
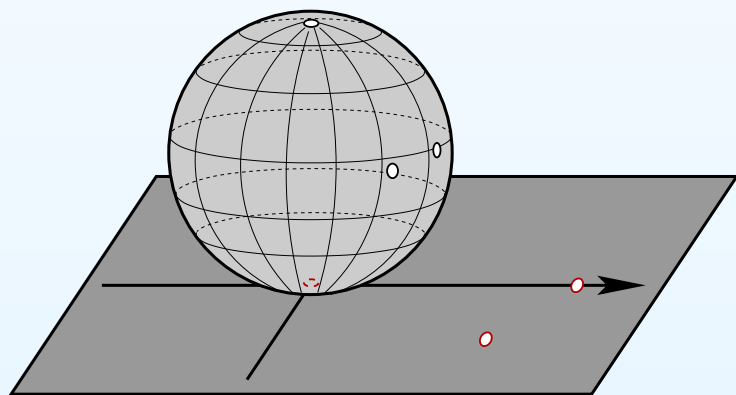

By the uniformization theorem, complex structures on a surface with marked points are in natural bijection with hyperbolic metrics of curvature -1 with cusps at the marked points, so the *moduli space* $\mathcal{M}_{0,4}$ can be also seen as the family of hyperbolic spheres with four cusps. Deforming the configuration of points we change the shape of the corresponding hyperbolic surface.

Families of hyperbolic surfaces

Consider a configuration of four distinct points on the Riemann sphere $\mathbb{C}P^1$. Using appropriate holomorphic automorphism of $\mathbb{C}P^1$ we can send three out of four points to 0 , 1 and ∞ . There is no more freedom: any further holomorphic automorphism of $\mathbb{C}P^1$ fixing 0 , 1 and ∞ is already the identity transformation. The remaining point serves as a complex parameter in the space $\mathcal{M}_{0,4}$ of configurations of four distinct points on $\mathbb{C}P^1$ (up to a holomorphic diffeomorphism).

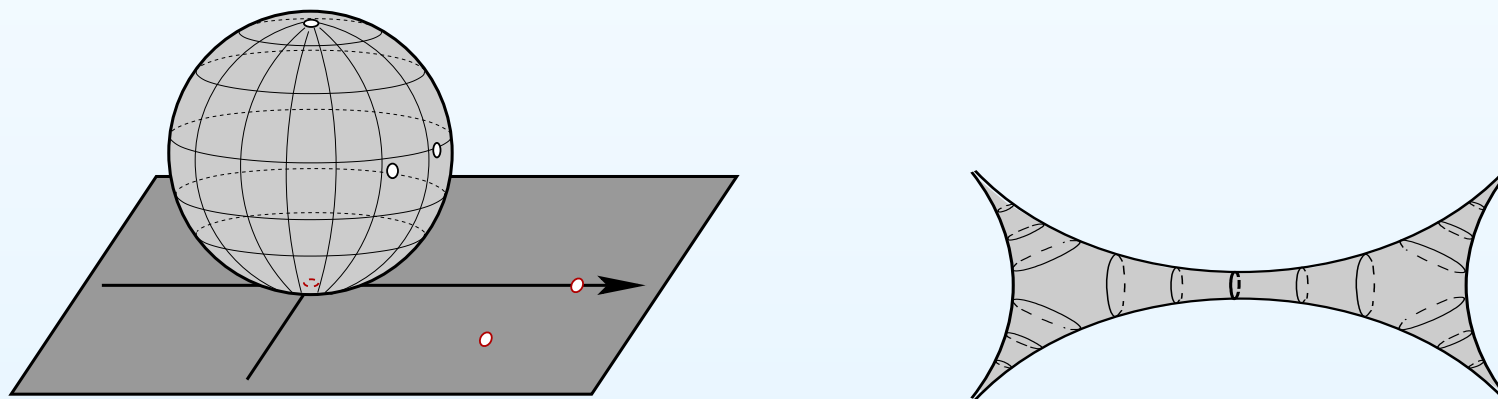

By the uniformization theorem, complex structures on a surface with marked points are in natural bijection with hyperbolic metrics of curvature -1 with cusps at the marked points, so the *moduli space* $\mathcal{M}_{0,4}$ can be also seen as the family of hyperbolic spheres with four cusps. Deforming the configuration of points we change the shape of the corresponding hyperbolic surface.

Moduli space $\mathcal{M}_{g,n}$

Similarly, we can consider the moduli space $\mathcal{M}_{0,n}$ of spheres with n cusps.

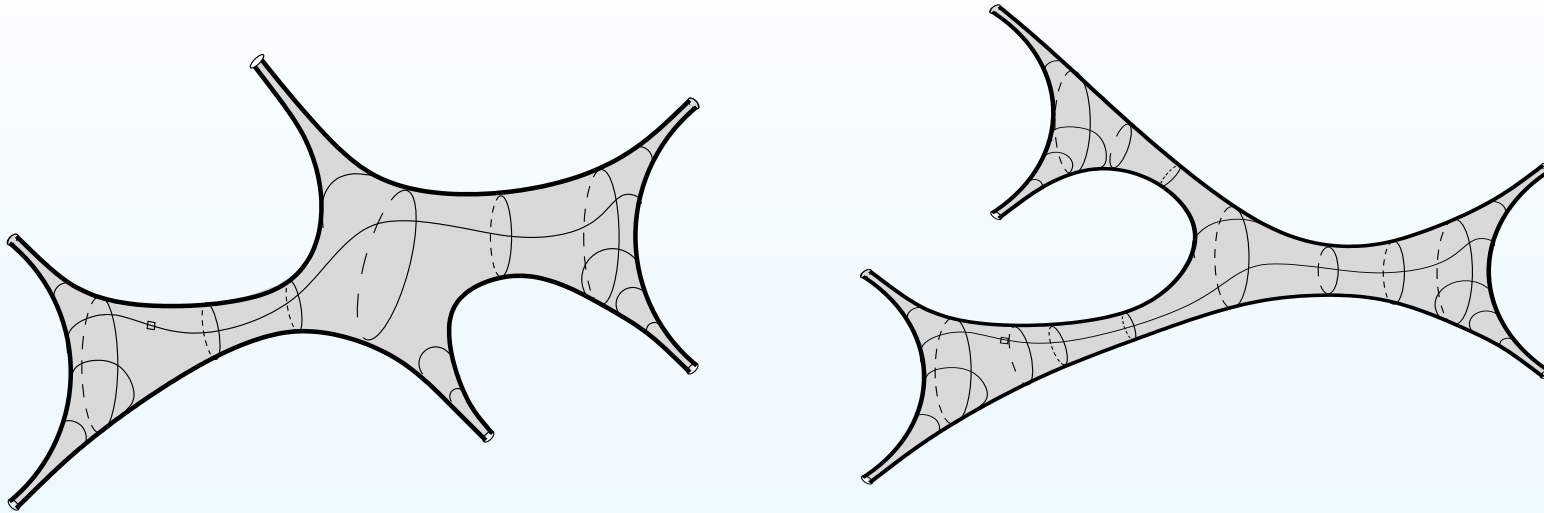

The space $\mathcal{M}_{g,n}$ of configurations of n distinct points on a smooth closed orientable Riemann surface of genus $g > 0$ is even richer. While the sphere admits only one complex structure, a surface of genus $g \geq 2$ admits complex $(3g - 3)$ -dimensional family of complex structures. As in the case of the Riemann sphere, complex structures on a smooth surface with marked points are in natural bijection with hyperbolic metrics of constant negative curvature with cusps at the marked points. For genus $g \geq 2$ one can let $n = 0$ and consider the space $\mathcal{M}_g = \mathcal{M}_{g,0}$ of hyperbolic surfaces without cusps.

Moduli space $\mathcal{M}_{g,n}$

Similarly, we can consider the moduli space $\mathcal{M}_{0,n}$ of spheres with n cusps.

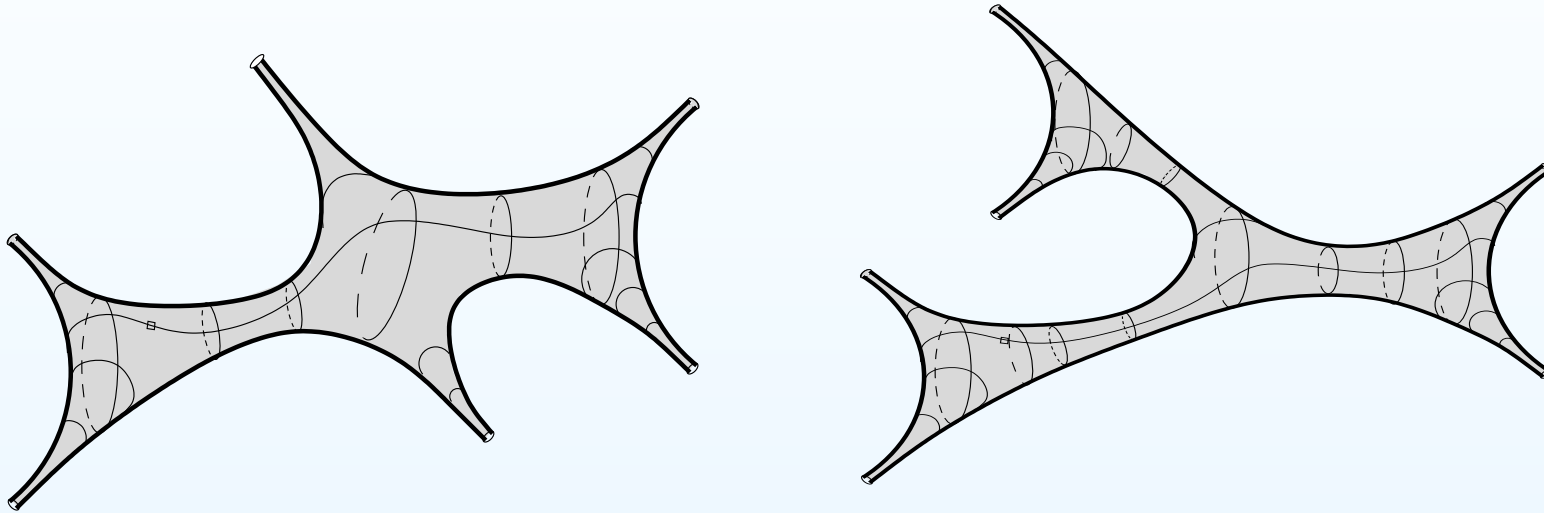

The space $\mathcal{M}_{g,n}$ of configurations of n distinct points on a smooth closed orientable Riemann surface of genus $g > 0$ is even richer. While the sphere admits only one complex structure, a surface of genus $g \geq 2$ admits complex $(3g - 3)$ -dimensional family of complex structures. As in the case of the Riemann sphere, complex structures on a smooth surface with marked points are in natural bijection with hyperbolic metrics of constant negative curvature with cusps at the marked points. For genus $g \geq 2$ one can let $n = 0$ and consider the space $\mathcal{M}_g = \mathcal{M}_{g,0}$ of hyperbolic surfaces without cusps.

Hyperbolic geometry of
surfaces

Multicurves

- Multicurves

Mirzakhani's count

Average number of
simple closed
geodesics

Multicurves

Multicurves

Consider now several pairwise nonintersecting essential simple closed curves $\gamma_1, \dots, \gamma_k$ on a smooth surface $S_{g,n}$ of genus g with n punctures. We have seen that in the presence of a hyperbolic metric X on $S_{g,n}$ the simple closed curves become simple closed geodesics.

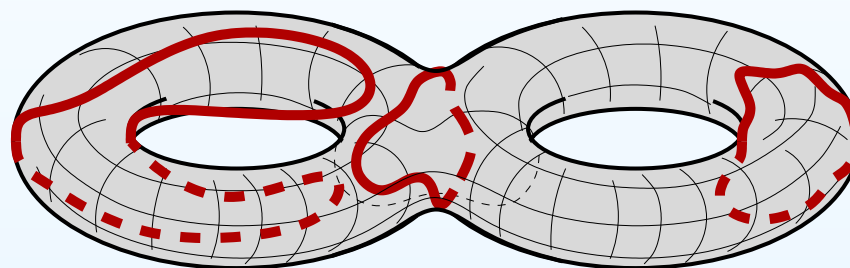

Fact. *For any hyperbolic metric X the simple closed geodesics representing $\gamma_1, \dots, \gamma_k$ do not have pairwise intersections.*

Multicurves

Consider now several pairwise nonintersecting essential simple closed curves $\gamma_1, \dots, \gamma_k$ on a smooth surface $S_{g,n}$ of genus g with n punctures. We have seen that in the presence of a hyperbolic metric X on $S_{g,n}$ the simple closed curves become simple closed geodesics.

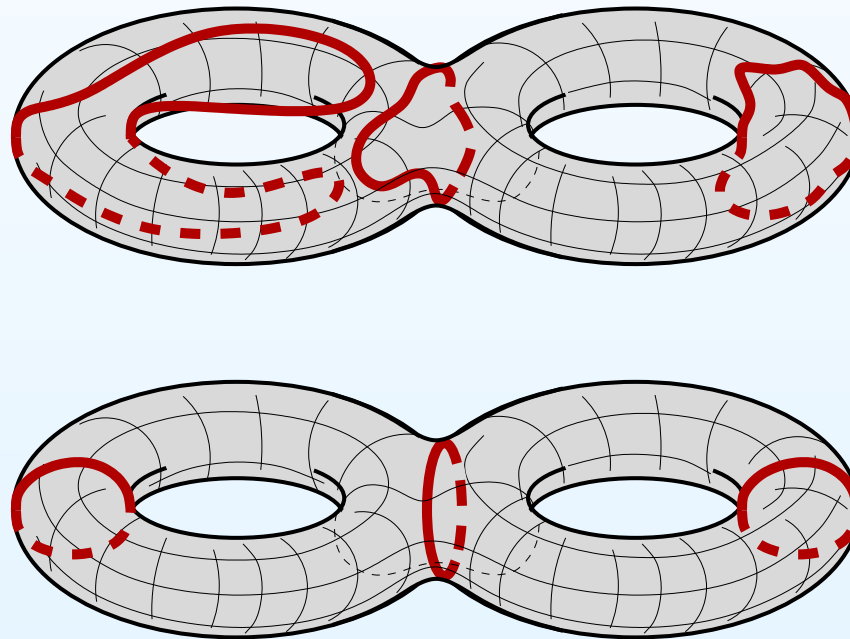

Fact. For any hyperbolic metric X the simple closed geodesics representing $\gamma_1, \dots, \gamma_k$ do not have pairwise intersections.

Example: primitive multicurves on a surface of genus two

The picture below illustrates all possible types of primitive multicurves on a surface of genus two without punctures.

Note that contracting all components of a multicurve we get a “stable curve” — a Riemann surface degenerated in one of the several regular ways. In this way the “topological types of primitive multicurves” on a smooth surface $S_{g,n}$ of genus g with n punctures are in the natural bijective correspondence with boundary classes of the Deligne–Mumford compactification $\overline{\mathcal{M}}_{g,n}$ of the moduli space of pointed complex curves.

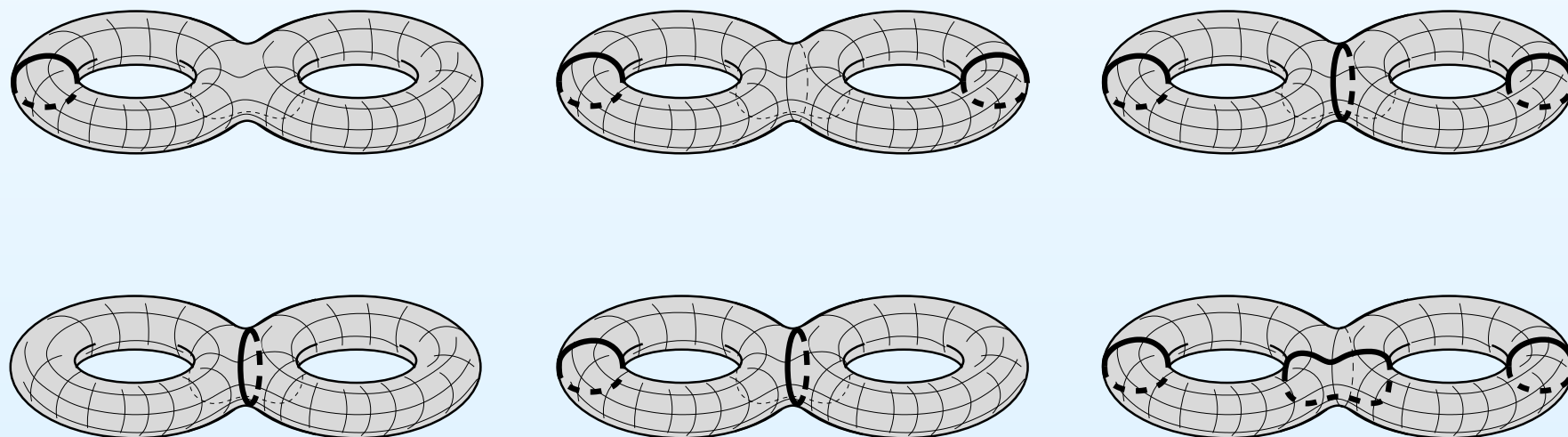

Simple closed multicurve, its topological type and underlying primitive multicurve

The first homology $H_1(M^2; \mathbb{Z})$ of the surface is great to study closed curves, but it ignores some interesting curves. The fundamental group $\pi_1(M^2)$ is also wonderful, but it is mainly designed to work with self-intersecting cycles. Thurston invented yet another structure to work with simple closed multicurves; in many aspects it resembles the first homology, but there is no group structure.

A general multicurve ρ :

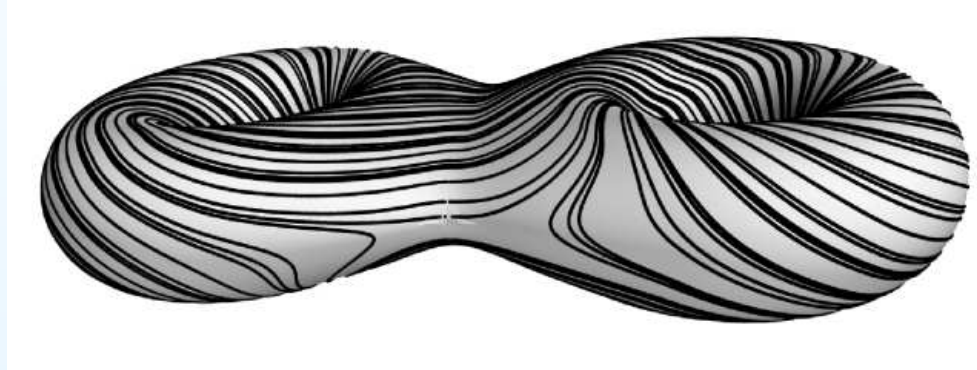

the canonical representative $\gamma = 3\gamma_1 + \gamma_2 + 2\gamma_3$ in its orbit $\text{Mod}_2 \cdot \rho$ under the action of the mapping class group and the associated *reduced* multicurve.

$$\gamma = 3\gamma_1 + \gamma_2 + 2\gamma_3$$

$$\gamma_{\text{reduced}} = \gamma_1 + \gamma_2 + \gamma_3$$

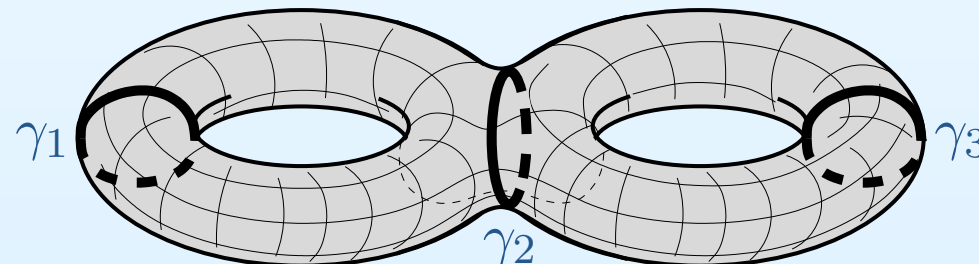
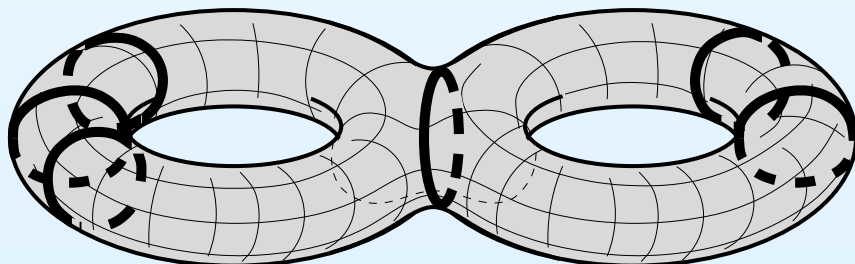

Hyperbolic geometry of
surfaces

Multicurves

Mirzakhani's count

- Geodesic representatives of multicurves
- Main counting results
- Example
- Separating versus non-separating

Average number of
simple closed
geodesics

Mirzakhani's count of hyperbolic geodesic multicurves: statement of results



Picture by François Labourie taken at CIRM

Geodesic representatives of multicurves

Consider now several pairwise nonintersecting essential simple closed curves $\gamma_1, \dots, \gamma_k$ on a smooth surface $S_{g,n}$ of genus g with n punctures. We have seen that in the presence of a hyperbolic metric X on $S_{g,n}$ the simple closed curves become simple closed geodesics.

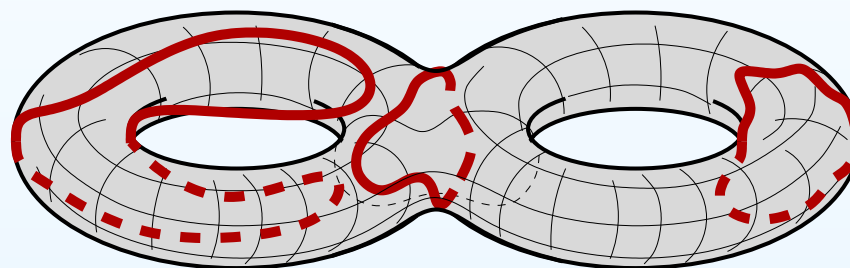

Fact. *For any hyperbolic metric X the simple closed geodesics representing $\gamma_1, \dots, \gamma_k$ do not have pairwise intersections.*

Geodesic representatives of multicurves

Consider now several pairwise nonintersecting essential simple closed curves $\gamma_1, \dots, \gamma_k$ on a smooth surface $S_{g,n}$ of genus g with n punctures. We have seen that in the presence of a hyperbolic metric X on $S_{g,n}$ the simple closed curves become simple closed geodesics.

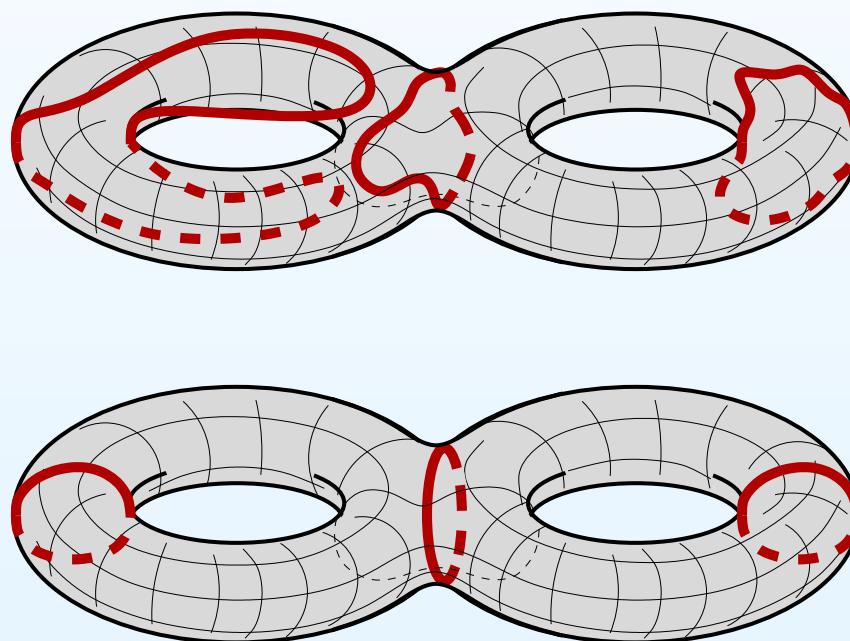

Fact. For any hyperbolic metric X the simple closed geodesics representing $\gamma_1, \dots, \gamma_k$ do not have pairwise intersections.

Hyperbolic length of a multicurve

We can consider formal linear combinations $\gamma := \sum_{i=1}^k a_i \gamma_i$ of such simple closed curves with positive coefficients. When all coefficients a_i are integer, we call such γ integral *multicurve*. In the presence of a hyperbolic metric X we define the hyperbolic length of a multicurve γ as $l_\gamma(X) := \sum_{i=1}^k a_i l_X(\gamma_i)$, where $l_X(\gamma_i)$ is the hyperbolic length of the simple closed geodesic in the free homotopy class of γ_i .

Denote by $s_X(L, \gamma)$ the number of simple closed geodesic multicurves on X of topological type $[\gamma]$ and of hyperbolic length at most L .

Hyperbolic length of a multicurve

We can consider formal linear combinations $\gamma := \sum_{i=1}^k a_i \gamma_i$ of such simple closed curves with positive coefficients. When all coefficients a_i are integer, we call such γ integral *multicurve*. In the presence of a hyperbolic metric X we define the hyperbolic length of a multicurve γ as $l_\gamma(X) := \sum_{i=1}^k a_i l_X(\gamma_i)$, where $l_X(\gamma_i)$ is the hyperbolic length of the simple closed geodesic in the free homotopy class of γ_i .

Denote by $s_X(L, \gamma)$ the number of simple closed geodesic multicurves on X of topological type $[\gamma]$ and of hyperbolic length at most L .

Main counting results

Theorem (M. Mirzakhani, 2008). *For any integral multi-curve γ and any hyperbolic surface X in $\mathcal{M}_{g,n}$ one has*

$$s_X(L, \gamma) \sim \mu_{\text{Th}}(B_X) \cdot \frac{c(\gamma)}{b_{g,n}} \cdot L^{6g-6+2n} \quad \text{as } L \rightarrow +\infty.$$

Here the quantity $\mu_{\text{Th}}(B_X)$ depends only on the hyperbolic metric X (it is the Thurston measure of the unit ball B_X in the metric X); $b_{g,n}$ is a global constant depending only on g and n (which is the average value of $B(X)$ over $\mathcal{M}_{g,n}$); $c(\gamma)$ depends only on the topological type of γ (expressed in terms of the Witten–Kontsevich correlators).

Main counting results

Theorem (M. Mirzakhani, 2008). *For any integral multi-curve γ and any hyperbolic surface X in $\mathcal{M}_{g,n}$ one has*

$$s_X(L, \gamma) \sim \mu_{\text{Th}}(B_X) \cdot \frac{c(\gamma)}{b_{g,n}} \cdot L^{6g-6+2n} \quad \text{as } L \rightarrow +\infty.$$

Here the quantity $\mu_{\text{Th}}(B_X)$ depends only on the hyperbolic metric X (it is the Thurston measure of the unit ball B_X in the metric X); $b_{g,n}$ is a global constant depending only on g and n (which is the average value of $B(X)$ over $\mathcal{M}_{g,n}$); $c(\gamma)$ depends only on the topological type of γ (expressed in terms of the Witten–Kontsevich correlators).

Corollary (M. Mirzakhani, 2008). *For any hyperbolic surface X in $\mathcal{M}_{g,n}$, and any two integral multicurves γ_1, γ_2 on a smooth surface $S_{g,n}$ considered up to the action of the mapping class group one obtains*

$$\lim_{L \rightarrow +\infty} \frac{s_X(L, \gamma_1)}{s_X(L, \gamma_2)} = \frac{c(\gamma_1)}{c(\gamma_2)}.$$

Example

A simple closed geodesic on a hyperbolic sphere with six cusps separates the sphere into two components. We either get three cusps on each of these components (as on the left picture) or two cusps on one component and four cusps on the complementary component (as on the right picture). Hyperbolic geometry excludes other partitions.

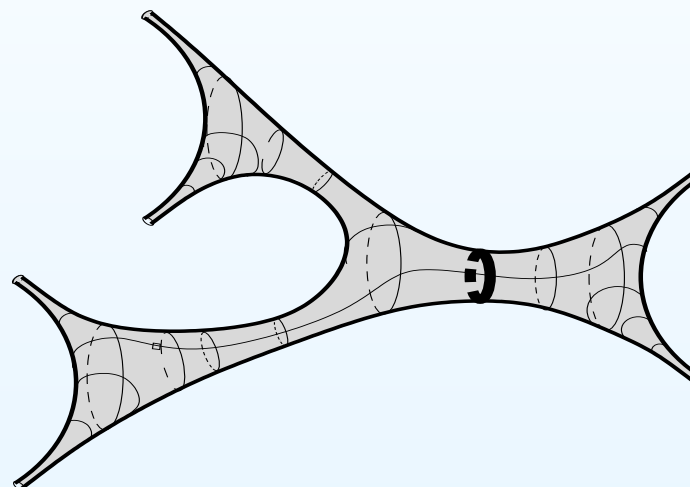
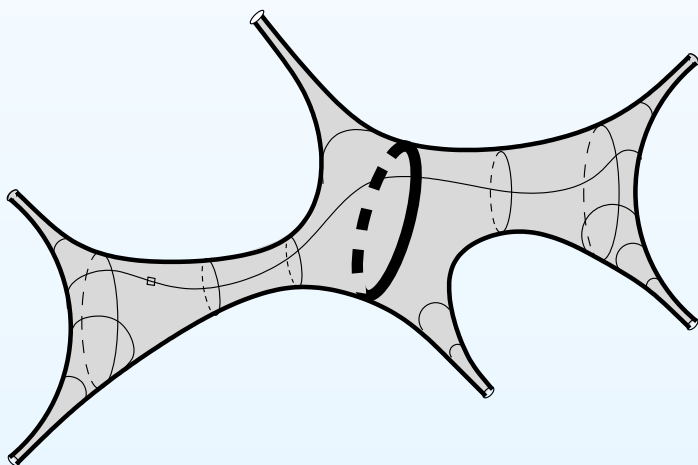

Example

A simple closed geodesic on a hyperbolic sphere with six cusps separates the sphere into two components. We either get three cusps on each of these components (as on the left picture) or two cusps on one component and four cusps on the complementary component (as on the right picture). Hyperbolic geometry excludes other partitions.

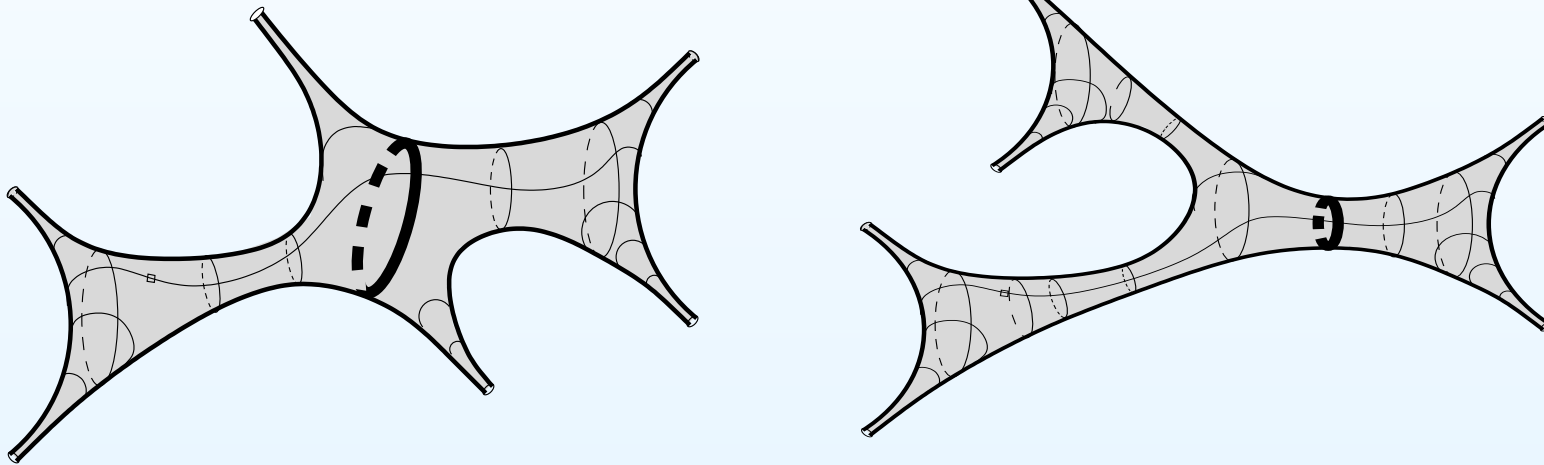

Example. (M. Mirzakhani, 2008); confirmed experimentally in 2017 by M. Bell; confirmed in 2017 by more implicit computer experiment of V. Delecroix and by other means.

$$\lim_{L \rightarrow +\infty} \frac{\text{Number of } (3 + 3)\text{-simple closed geodesics of length at most } L}{\text{Number of } (2 + 4)\text{-simple closed geodesics of length at most } L} = \frac{4}{3}.$$

Separating versus non-separating simple closed curves in $g = 2$

Ratio of asymptotic frequencies (Mirzakhani'08). Genus $g = 2$

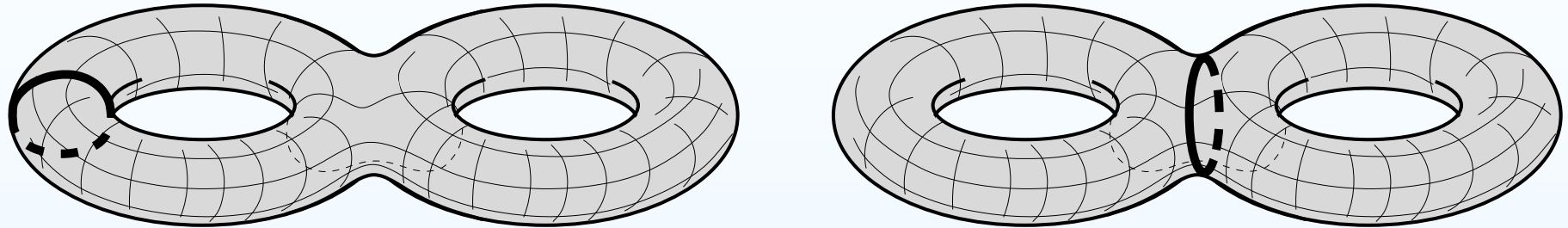

$$\lim_{L \rightarrow +\infty} \frac{\text{Number of **separating** simple closed geodesics of length at most } L}{\text{Number of **non-separating** simple closed geodesics of length at most } L} = \frac{1}{6}$$

Separating versus non-separating simple closed curves in $g = 2$

Ratio of asymptotic frequencies (Mirzakhani'08). Genus $g = 2$

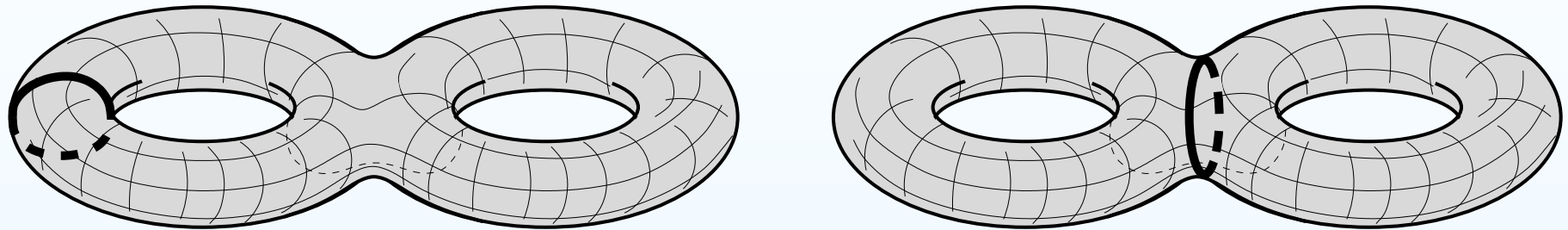

$$\lim_{L \rightarrow +\infty} \frac{\text{Number of **separating** simple closed geodesics of length at most } L}{\text{Number of **non-separating** simple closed geodesics of length at most } L} = \frac{1}{24}$$

after correction of a tiny bug in Mirzakhani's calculation.

Separating versus non-separating simple closed curves in $g = 2$

Ratio of asymptotic frequencies (Mirzakhani'08). Genus $g = 2$

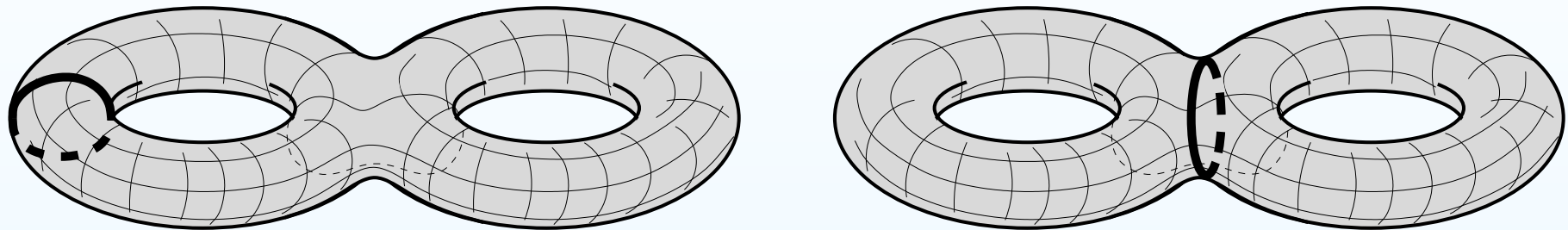

$$\lim_{L \rightarrow +\infty} \frac{\text{Number of **separating** simple closed geodesics of length at most } L}{\text{Number of **non-separating** simple closed geodesics of length at most } L} = \frac{1}{48}$$

after further correction of another trickier bug in Mirzakhani's calculation. Confirmed by crosscheck with Masur–Veech volume of \mathcal{Q}_2 computed by E. Goujard using the method of Eskin–Okounkov. Confirmed by calculation of M. Kazarian; by independent computer experiment of V. Delecroix; by extremely heavy and elaborate recent experiment of M. Bell. Most recently it was independently confirmed by V. Erlandsson, K. Rafi, J. Souto and by A. Wright by methods independent of ours.

Multicurves on a surface of genus two and their frequencies

The picture below illustrates all topological types of primitive multicurves on a surface of genus two without punctures; the fractions give frequencies of non-primitive multicurves γ having a reduced multicurve $\gamma_{reduced}$ of the corresponding type.

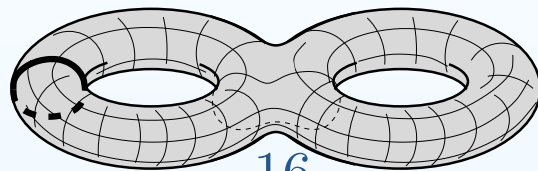

$$\frac{16}{63}$$

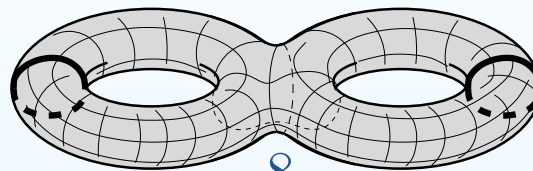

$$\frac{8}{15}$$

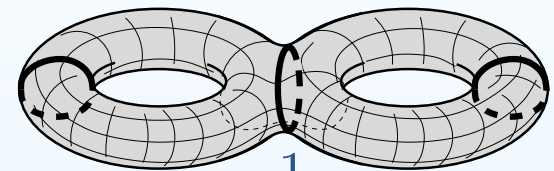

$$\frac{1}{9}$$

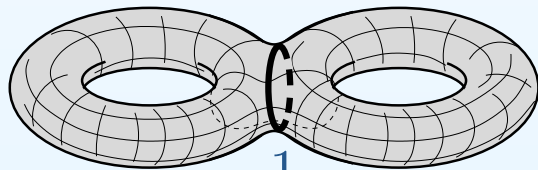

$$\frac{1}{189}$$

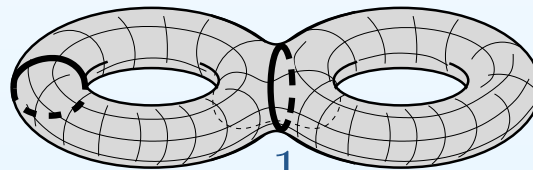

$$\frac{1}{45}$$

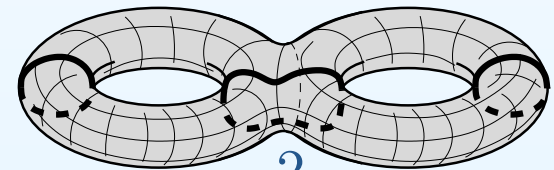

$$\frac{2}{27}$$

In genus 3 there are already 41 types of multicurves, in genus 4 there are 378 types, in genus 5 there are 4554 types and this number grows faster than exponentially when genus g grows. It becomes pointless to produce tables: we need to extract a reasonable sub-collection of most common types which ideally, carry all Thurston's measure when $g \rightarrow +\infty$.

Hyperbolic geometry of surfaces

Multicurves

Mirzakhani's count

Average number of simple closed geodesics

- Bordered hyperbolic surfaces
- Hyperbolic pairs of pants
- Twist parameter
- Fenchel–Nielsen coordinates
- Mirzakhani–Weil–Petersson volumes
- Averaging the counting function
- Convenient cover: model case
- Integration over $\mathcal{M}_{1,1}$

Average number of simple closed geodesics

Bordered hyperbolic surfaces

Cutting a hyperbolic surface by several pairwise disjoint simple closed geodesics we get one or several *bordered* hyperbolic surfaces with geodesic boundary components.

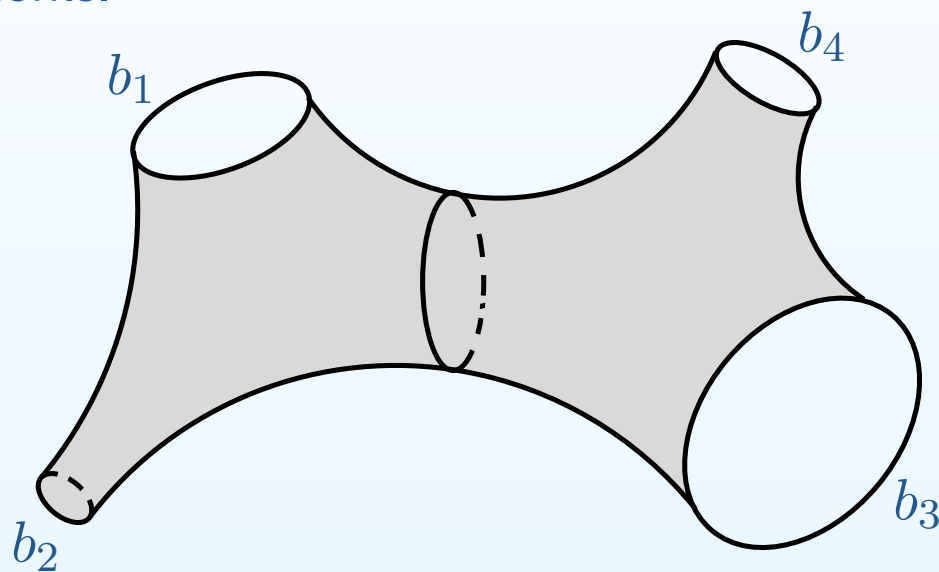

Bordered hyperbolic surfaces

Cutting a hyperbolic surface by several pairwise disjoint simple closed geodesics we get one or several *bordered* hyperbolic surfaces with geodesic boundary components.

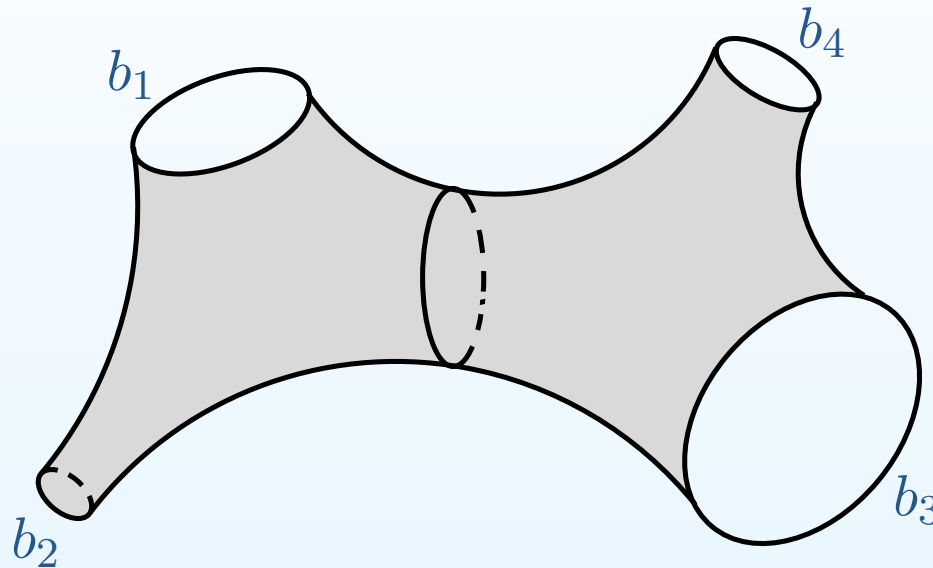

Denote by $\mathcal{M}_{g,n}(b_1, \dots, b_n)$ the moduli space of hyperbolic surfaces of genus g with n geodesic boundary components of lengths b_1, \dots, b_n .

By convention, the zero value $b_i = 0$ corresponds to a cusp so the moduli space $\mathcal{M}_{g,n}$ corresponds to $\mathcal{M}_{g,n}(0, \dots, 0)$ in this more general setting.

Hyperbolic pairs of pants

Topologically, a hyperbolic *pair of pants* $P \in \mathcal{M}_{0,3}(b_1, b_2, b_3)$ is a sphere with three holes. For any triple of nonnegative numbers $(b_1, b_2, b_3) \in \mathbb{R}_+^3$ there exists a unique hyperbolic pair of pants $P(b_1, b_2, b_3)$ with geodesic boundaries of given lengths (assuming that the boundary components of P are numbered).

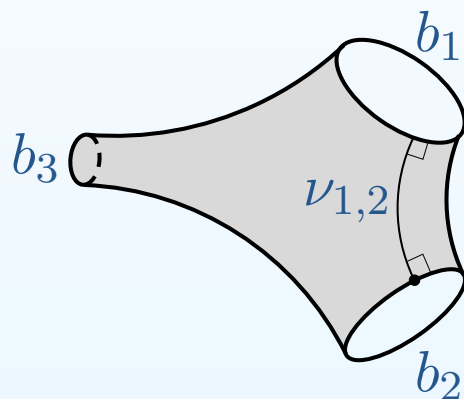

Hyperbolic pairs of pants

Topologically, a hyperbolic *pair of pants* $P \in \mathcal{M}_{0,3}(b_1, b_2, b_3)$ is a sphere with three holes. For any triple of nonnegative numbers $(b_1, b_2, b_3) \in \mathbb{R}_+^3$ there exists a unique hyperbolic pair of pants $P(b_1, b_2, b_3)$ with geodesic boundaries of given lengths (assuming that the boundary components of P are numbered).

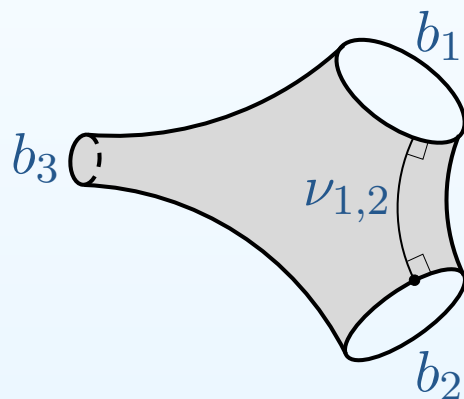

Two geodesic boundary components γ_1, γ_2 of any hyperbolic pair of pants P can be joined by a single geodesic segment $\nu_{1,2}$ orthogonal to both γ_1 and γ_2 . Thus, every geodesic boundary component γ of any hyperbolic pair of pants might be endowed with a canonical distinguished point.

Hyperbolic pairs of pants

Topologically, a hyperbolic *pair of pants* $P \in \mathcal{M}_{0,3}(b_1, b_2, b_3)$ is a sphere with three holes. For any triple of nonnegative numbers $(b_1, b_2, b_3) \in \mathbb{R}_+^3$ there exists a unique hyperbolic pair of pants $P(b_1, b_2, b_3)$ with geodesic boundaries of given lengths (assuming that the boundary components of P are numbered).

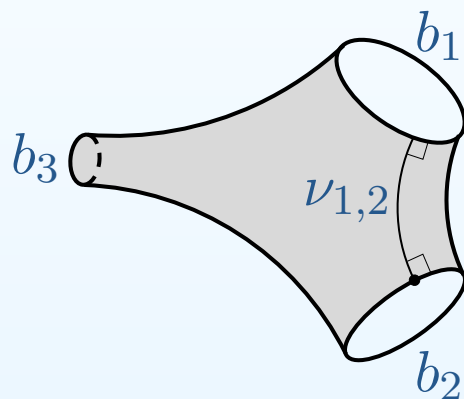

Two geodesic boundary components γ_1, γ_2 of any hyperbolic pair of pants P can be joined by a single geodesic segment $\nu_{1,2}$ orthogonal to both γ_1 and γ_2 . Thus, every geodesic boundary component γ of any hyperbolic pair of pants might be endowed with a canonical distinguished point.

The construction can be extended to the situation, when both remaining boundary components of the pair of pants are represented by cusps.

Twist parameter

Two hyperbolic pairs of pants $P'(b'_1, b'_2, \ell)$ and $P''(b''_1, b''_2, \ell)$ sharing the same length $\ell > 0$ of one of the geodesic boundary components can be glued together. The hyperbolic metric on the resulting hyperbolic surface Y is perfectly smooth and the common geodesic boundary of P' and P'' becomes a simple closed geodesic γ on Y .

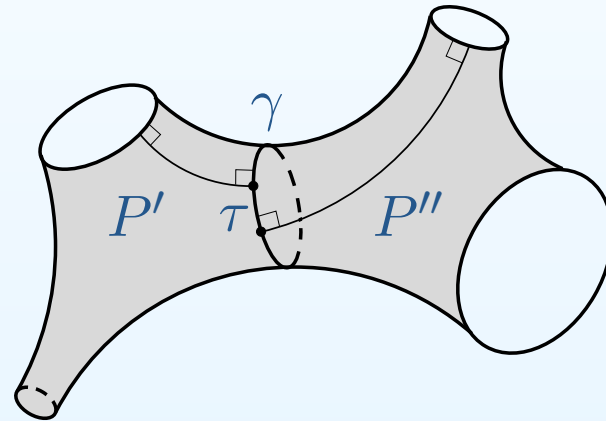

Twist parameter

Two hyperbolic pairs of pants $P'(b'_1, b'_2, \ell)$ and $P''(b''_1, b''_2, \ell)$ sharing the same length $\ell > 0$ of one of the geodesic boundary components can be glued together. The hyperbolic metric on the resulting hyperbolic surface Y is perfectly smooth and the common geodesic boundary of P' and P'' becomes a simple closed geodesic γ on Y .

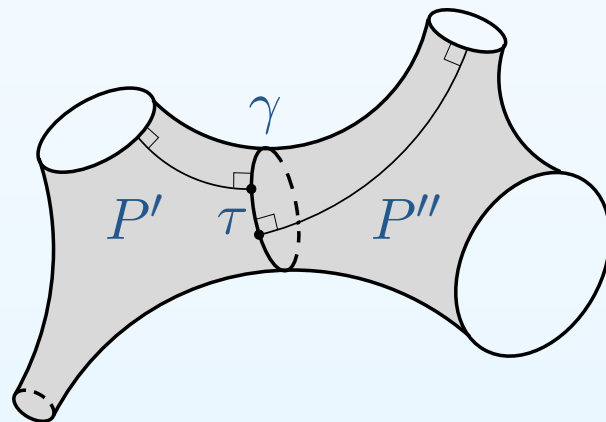

Each geodesic boundary component of any pair of pants is endowed with a distinguished point. These distinguished points record how the pairs of pants P' and P'' are twisted with respect to each other. Hyperbolic surfaces $Y(\tau)$ corresponding to different values of the twist parameter τ in the range $[0, \ell[$ are generically not isometric.

Fenchel–Nielsen coordinates

Any hyperbolic surface X of genus g with n geodesic boundary components admits a decomposition in hyperbolic pairs of pants glued along simple closed geodesics $\gamma_1, \dots, \gamma_{3g-3+n}$. Lengths $\ell_{\gamma_i}(X)$ of the resulting simple closed geodesics γ_i involved in pants decomposition of X and twists $\tau_{\gamma_i}(X)$ along them serve as local *Fenchel–Nielsen coordinates* in $\mathcal{M}_{g,n}(b_1, \dots, b_n)$.

Fenchel–Nielsen coordinates

Any hyperbolic surface X of genus g with n geodesic boundary components admits a decomposition in hyperbolic pairs of pants glued along simple closed geodesics $\gamma_1, \dots, \gamma_{3g-3+n}$. Lengths $\ell_{\gamma_i}(X)$ of the resulting simple closed geodesics γ_i involved in pants decomposition of X and twists $\tau_{\gamma_i}(X)$ along them serve as local *Fenchel–Nielsen coordinates* in $\mathcal{M}_{g,n}(b_1, \dots, b_n)$.

By the work of W. Goldman $\mathcal{M}_{g,n}(b_1, \dots, b_n)$ carries a natural closed non-degenerate 2-form ω_{WP} called the *Weil–Petersson symplectic form*.

Fenchel–Nielsen coordinates

Any hyperbolic surface X of genus g with n geodesic boundary components admits a decomposition in hyperbolic pairs of pants glued along simple closed geodesics $\gamma_1, \dots, \gamma_{3g-3+n}$. Lengths $\ell_{\gamma_i}(X)$ of the resulting simple closed geodesics γ_i involved in pants decomposition of X and twists $\tau_{\gamma_i}(X)$ along them serve as local *Fenchel–Nielsen coordinates* in $\mathcal{M}_{g,n}(b_1, \dots, b_n)$.

By the work of W. Goldman $\mathcal{M}_{g,n}(b_1, \dots, b_n)$ carries a natural closed non-degenerate 2-form ω_{WP} called the *Weil–Petersson symplectic form*.

S. Wolpert proved that ω_{WP} has particularly simple expression in Fenchel–Nielsen coordinates. No matter what pants decomposition we chose, we get

$$\omega_{WP} = \sum_{i=1}^{3g-3+n} d\ell_{\gamma_i} \wedge d\tau_{\gamma_i}.$$

Mirzakhani–Weil–Petersson volumes

The wedge power ω^n of a symplectic form on a manifold M^{2n} of real dimension $2n$ defines a volume form on M^{2n} .

Mirzakhani–Weil–Petersson volumes

The wedge power ω^n of a symplectic form on a manifold M^{2n} of real dimension $2n$ defines a volume form on M^{2n} .

The volume $V_{g,n}(b_1, \dots, b_n)$ of the moduli space $\mathcal{M}_{g,n}(b_1, \dots, b_n)$ with

respect to the volume form $\frac{1}{(3g - 3 + n)!} \cdot \omega_{WP}^{3g-3+n}$ is called the

Mirzakhani–Weil–Petersson volume of the moduli space $\mathcal{M}_{g,n}(b_1, \dots, b_n)$; it is known to be finite.

Mirzakhani–Weil–Petersson volumes

The wedge power ω^n of a symplectic form on a manifold M^{2n} of real dimension $2n$ defines a volume form on M^{2n} .

The volume $V_{g,n}(b_1, \dots, b_n)$ of the moduli space $\mathcal{M}_{g,n}(b_1, \dots, b_n)$ with respect to the volume form $\frac{1}{(3g - 3 + n)!} \cdot \omega_{WP}^{3g-3+n}$ is called the

Mirzakhani–Weil–Petersson volume of the moduli space $\mathcal{M}_{g,n}(b_1, \dots, b_n)$; it is known to be finite.

Example: $\mathcal{M}_{1,1}$.

$$\text{Vol}_{WP} \mathcal{M}_{1,1}(b_1) = \frac{1}{24} (b_1^2 + 4\pi^2).$$

Mirzakhani–Weil–Petersson volumes

The wedge power ω^n of a symplectic form on a manifold M^{2n} of real dimension $2n$ defines a volume form on M^{2n} .

The volume $V_{g,n}(b_1, \dots, b_n)$ of the moduli space $\mathcal{M}_{g,n}(b_1, \dots, b_n)$ with respect to the volume form $\frac{1}{(3g - 3 + n)!} \cdot \omega_{WP}^{3g-3+n}$ is called the

Mirzakhani–Weil–Petersson volume of the moduli space $\mathcal{M}_{g,n}(b_1, \dots, b_n)$; it is known to be finite.

Example: $\mathcal{M}_{1,1}$.

$$\text{Vol}_{WP} \mathcal{M}_{1,1}(b_1) = \frac{1}{24} (b_1^2 + 4\pi^2).$$

Example: $\mathcal{M}_{1,2}$.

$$\text{Vol}_{WP} \mathcal{M}_{1,2}(b_1, b_2) = \frac{1}{192} (b_1^2 + b_2^2 + 4\pi^2) (b_1^2 + b_2^2 + 12\pi^2).$$

Averaging the counting function: statement of results

We are interested in counting the number $s_X(L, \gamma)$ of simple closed geodesic multicurves on $X \in \mathcal{M}_{g,n}$ of topological type $[\gamma]$ and of hyperbolic length at most L . Following Mirzakhani, we shall count first the *average* of the quantity $s_X(L, \gamma)$ over $\mathcal{M}_{g,n}$ with respect to the Weil–Petersson volume element:

$$P(L, \gamma) := \int_{\mathcal{M}_{g,n}} s_X(L, \gamma) dX .$$

Averaging the counting function: statement of results

We are interested in counting the number $s_X(L, \gamma)$ of simple closed geodesic multicurves on $X \in \mathcal{M}_{g,n}$ of topological type $[\gamma]$ and of hyperbolic length at most L . Following Mirzakhani, we shall count first the *average* of the quantity $s_X(L, \gamma)$ over $\mathcal{M}_{g,n}$ with respect to the Weil–Petersson volume element:

$$P(L, \gamma) := \int_{\mathcal{M}_{g,n}} s_X(L, \gamma) dX .$$

Theorem (M. Mirzakhani, 2008). *The average number $P(L, \gamma)$ of closed geodesic multicurves of topological type $[\gamma]$ and of hyperbolic length at most L is a polynomial in L of degree $6g - 6 + 2n$. The leading coefficient of this polynomial*

$$c_\gamma := \lim_{L \rightarrow +\infty} \frac{P(L, \gamma)}{L^{6g-6+2n}}$$

is expressed in terms of the Weil–Petersson volumes of the associated moduli space of bordered hyperbolic surfaces, or, more precisely, in terms of the appropriate characteristic numbers of the form

$$\int_{M_{g_i, n_i}} \psi_1^{d_1} \cdots \psi_{n_i}^{d_{n_i}} \quad \text{where } d_1 + \cdots + d_{n_i} = 3g_i - 3 + n_i .$$

Convenient cover: model case

Consider the cover $\mathcal{M}_{1,1}^\gamma$ over $\mathcal{M}_{1,1}$ where the point of the cover $\mathcal{M}_{1,1}^\gamma$ is a hyperbolic surface X endowed with a distinguished simple closed geodesic α . The fiber of the cover can be identified with $\text{Mod}_{1,1} \cdot [\gamma]$, where γ is an essential simple closed curve on a once punctured torus.

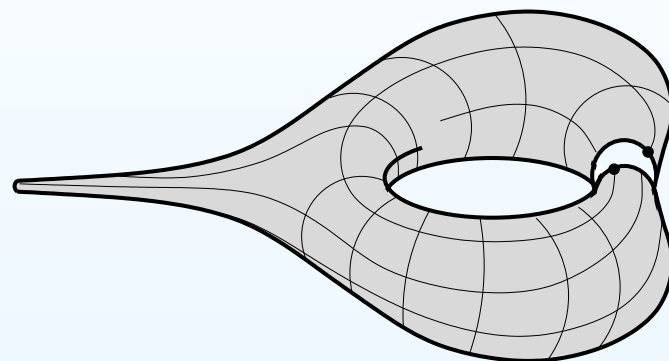

twist τ where $0 \leq \tau < \ell_X(\alpha)$

Convenient cover: model case

Consider the cover $\mathcal{M}_{1,1}^\gamma$ over $\mathcal{M}_{1,1}$ where the point of the cover $\mathcal{M}_{1,1}^\gamma$ is a hyperbolic surface X endowed with a distinguished simple closed geodesic α . The fiber of the cover can be identified with $\text{Mod}_{1,1} \cdot [\gamma]$, where γ is an essential simple closed curve on a once punctured torus.

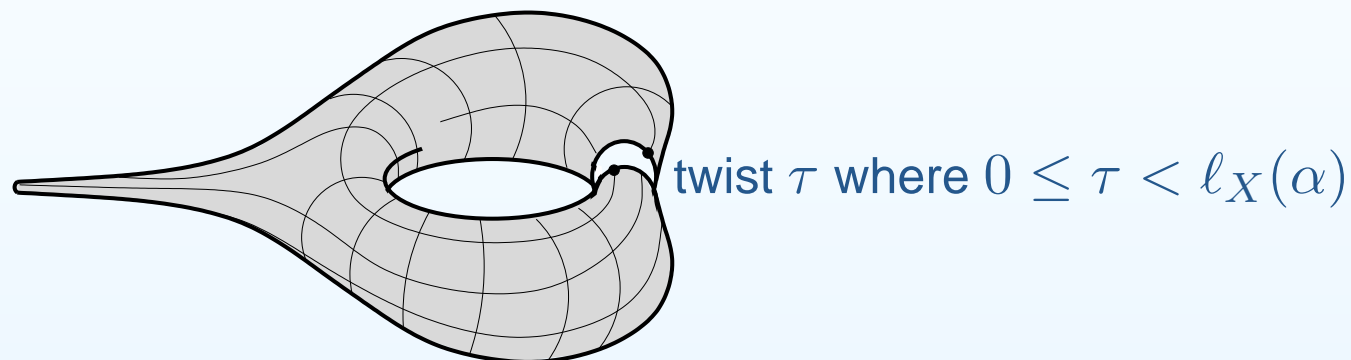

The cover $\mathcal{M}_{1,1}^\gamma$ admits global coordinates. Namely, given $(X, \alpha) \in \mathcal{M}_{1,1}^\gamma$ cut X open along the closed geodesic α . We get a hyperbolic pair of pants $P(l, l, 0)$; two geodesic boundary components of it have the same length $l = \ell_X(\alpha)$ and the third boundary component is the cusp. Reciprocally, from any hyperbolic pair of pants $P(l, l, 0)$ we can glue a hyperbolic surface X endowed with a distinguished simple closed geodesic α . Constructing X from the pair of pants $P(l, l, 0)$ we have to choose the value of the twist parameter τ in the interval $[0, l[$, where $l = \ell_X(\alpha)$ is the length of the geodesic boundary.

Integration over $\mathcal{M}_{1,1}$

Mirzakhani observed that having a continuous function $f_\gamma(X)$ on $\mathcal{M}_{1,1}$ of the form

$$f_\gamma(X) = \sum_{[\alpha] \in \text{Mod}_{1,1} \cdot [\gamma]} f(\ell_X(\alpha))$$

we can integrate it over $\mathcal{M}_{1,1}$ as follows

$$\begin{aligned} \int_{\mathcal{M}_{1,1}} \sum_{[\alpha] \in \text{Mod}_{1,1} \cdot [\gamma]} f(\ell_\alpha(X)) dX &= \int_{\mathcal{M}_{1,1}^\gamma} f(\ell_\alpha(X)) dl d\tau = \\ &= \int_0^\infty f(l) \int_0^l dl d\tau = \int_0^\infty f(l) l dl . \end{aligned}$$

Integration over $\mathcal{M}_{1,1}$

Mirzakhani observed that having a continuous function $f_\gamma(X)$ on $\mathcal{M}_{1,1}$ of the form

$$f_\gamma(X) = \sum_{[\alpha] \in \text{Mod}_{1,1} \cdot [\gamma]} f(\ell_X(\alpha))$$

we can integrate it over $\mathcal{M}_{1,1}$ as follows

$$\begin{aligned} \int_{\mathcal{M}_{1,1}} \sum_{[\alpha] \in \text{Mod}_{1,1} \cdot [\gamma]} f(\ell_\alpha(X)) dX &= \int_{\mathcal{M}_{1,1}^\gamma} f(\ell_\alpha(X)) dl d\tau = \\ &= \int_0^\infty f(l) \int_0^l dl d\tau = \int_0^\infty f(l) l dl. \end{aligned}$$

Note that our counting function $s_X(L, \gamma)$ is exactly of this form with $f = \chi([0, L])$. In this particular case we get

$$P(L, \gamma) := \int_{\mathcal{M}_{1,1}} s_X(L, \gamma) dX = \int_0^\infty \chi([0, L]) l dl = \int_0^L l dl = \frac{L^2}{2}.$$

Integration over the moduli space \mathcal{M}_g

Let γ be a nonseparating simple closed curve on S_g . Consider the analogous cover \mathcal{M}_g^γ over \mathcal{M}_g where the point of the cover is a hyperbolic surface X endowed with a distinguished simple closed geodesic α . Cutting X open along α we get a bordered hyperbolic surface $Y(l, l)$ in $\mathcal{M}_{g-1,2}(l, l)$, where $l = \ell_X(\alpha)$.

Integration over the moduli space \mathcal{M}_g

Let γ be a nonseparating simple closed curve on S_g . Consider the analogous cover \mathcal{M}_g^γ over \mathcal{M}_g where the point of the cover is a hyperbolic surface X endowed with a distinguished simple closed geodesic α . Cutting X open along α we get a bordered hyperbolic surface $Y(l, l)$ in $\mathcal{M}_{g-1,2}(l, l)$, where $l = \ell_X(\alpha)$. For $f = \chi([0, L])$ we can integrate the function

$$s_X(L, \gamma) = \sum_{[\alpha] \in \text{Mod}_g \cdot [\gamma]} f(\ell_X(\alpha)) = \sum_{[\alpha] \in \text{Mod}_g \cdot [\gamma]} \chi([0, L])(\ell_X(\alpha))$$

over \mathcal{M}_g as before:

$$\begin{aligned} P(L, \gamma) &:= \int_{\mathcal{M}_g} s_X(L, \gamma) dX = \int_{\mathcal{M}_g^\gamma} f(\ell_X(\alpha)) dX = \\ &= \frac{1}{2} \int_0^L \int_0^l \int_{\mathcal{M}_{g-1,2}(l,l)} dY dl d\tau = \frac{1}{2} \int_0^L \text{Vol}_{\text{WP}}(\mathcal{M}_{g-1,2}(l, l)) l dl. \end{aligned}$$

Integration over the moduli space \mathcal{M}_g

Let γ be a nonseparating simple closed curve on S_g . Consider the analogous cover \mathcal{M}_g^γ over \mathcal{M}_g where the point of the cover is a hyperbolic surface X endowed with a distinguished simple closed geodesic α . Cutting X open along α we get a bordered hyperbolic surface $Y(l, l)$ in $\mathcal{M}_{g-1,2}(l, l)$, where $l = \ell_X(\alpha)$. For $f = \chi([0, L])$ we can integrate the function

$$s_X(L, \gamma) = \sum_{[\alpha] \in \text{Mod}_g \cdot [\gamma]} f(\ell_X(\alpha)) = \sum_{[\alpha] \in \text{Mod}_g \cdot [\gamma]} \chi([0, L])(\ell_X(\alpha))$$

over \mathcal{M}_g as before:

$$\begin{aligned} P(L, \gamma) &:= \int_{\mathcal{M}_g} s_X(L, \gamma) dX = \int_{\mathcal{M}_g^\gamma} f(\ell_X(\alpha)) dX = \\ &= \frac{1}{2} \int_0^L \int_0^l \int_{\mathcal{M}_{g-1,2}(l,l)} dY dl d\tau = \frac{1}{2} \int_0^L \text{Vol}_{\text{WP}}(\mathcal{M}_{g-1,2}(l, l)) l dl. \end{aligned}$$

Mirzakhani proved that $\text{Vol}_{\text{WP}}(\mathcal{M}_{g-1,2}(l, l))$ is an explicit polynomial in l of degree $6(g-1) - 6 + 2 \cdot 2$, so $P(L, \gamma)$ is a polynomial of degree $6g - 6$.